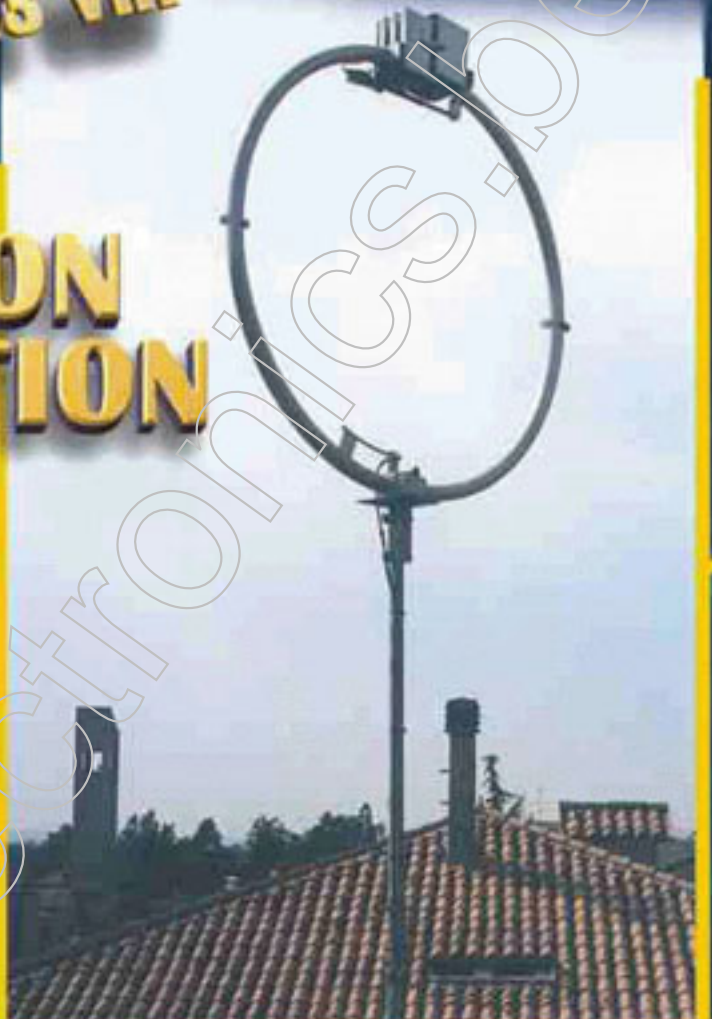


HF  
**LOOP ANTENNA**  
18 VHF

**PRESENTATION**  
and **INSTRUCTION**  
**MANUAL**





\* Perfect coexistence between the **LOOP ANTENNA** and the other antennas.

*...a heartfelt thanks to I3GFB, Gaetano and I3GGT, Giovanni for their precious collaborations offered throughout the preparation of this manual \*.*

Layout and Graphics by: Tre Emme Studio Verona

CRO MAZZONI RADIOCOMUNICAZIONI - Verona, Italy.



## TABLE OF CONTENTS

	<u>page</u>
<b><u>SECTION I</u></b>	
Introduction.....	6
Overview of the project.....	7
Materials selection.....	10
Mechanical assembly.....	11
Loop controller.....	12
Packaging technique.....	13
Electrical/mechanical specifications and sketch of <b>Baby</b> .....	14
Electrical/mechanical specifications and sketch of <b>Midi</b> .....	15
Electrical/mechanical specifications and sketch of <b>Maxi</b> .....	16
<b><u>SECTION II</u></b>	
Contents of <b>Baby</b> shipment.....	18
Contents of <b>Midi</b> shipment.....	19
Contents of <b>Maxi</b> shipment.....	20
<b><u>SECTION III</u></b>	
Where to install the <b>LOOP ANTENNA</b> .....	22
Assembly of the <b>LOOP ANTENNA Baby</b> .....	23
Assembly of the <b>LOOP ANTENNA Midi / Maxi</b> .....	27
<b><u>SECTION IV</u></b>	
Electrical Connections ( <i>testing before final installation</i> ).....	40
<b>LOOP ANTENNA</b> tuning, brief working description and first connection.....	43
<b>LOOP ANTENNA</b> - patents, warranty, conditions, sales and shipping details, special antennas.....	47



\* One of the many possible areas to install the **LOOP ΑΝΤΕΝΝΑ....**  
is in a garden.



**SECTION I**

[www.hfelectronics.be](http://www.hfelectronics.be)



## Introduction

Thank you for purchasing the I3VHF **LOOP ANTENNA**, and congratulations on your selection. You are the owner of the best magnetic small loop ever produced worldwide, professional or otherwise. We are certain that after having carefully read this manual, correctly assembled the antenna, and familiarized yourself with the **LOOP ANTENNA**, this product will bring you much enjoyment and satisfaction for years.

We do not recommend rushing through assembly and set up of the antenna in order to quickly make a first connection. To understand the antenna and its uses requires a gradual learning process. Following the suggested procedure in this manual will guarantee the best assembly and most accurate tuning, therefore maximizing the potential of the **LOOP ANTENNA**.



## Overview of the project

The **LOOP ANTENNA** was designed for amateur and professional radio operators who have limited space for their antennas, yet still want a quality antenna that meets their needs.

The **LOOP ANTENNA** has smaller dimensions, but has high efficiency in order to compete with the classic dipole. The antenna's bandwidth covers more than one band within the amateur radio frequency allocations as well as enough bandwidth to support commercial, military, and civilian use.

The task of creating an antenna of a manageable size which could still perform like a full size antenna was not easy. The antenna was designed and produced by amateur radio operator, I3VHF, who dedicated his professional life to experimentation and testing in order to produce such a superior product.

The project started with an analysis of the loop antennas from the first loop ever built, designed by K.H. Patterson for the U.S. Armed Forces, to the presently marketed antennas; this analysis covers a span of about 30 and more years. After this analysis I3VHF began creating the first designs, constructions and experiments. He did this to improve the best of that time, to make a radiating instrument which became closer to the ideal small loop antenna.

The ideal loop antenna should have:

- Reduced dimensions
- Robustness
- Maximum efficiency
- Use of the best materials
- Durability
- Easy assembly and operation
- Fair price for the equipment



After many experiments, results were attained under the same conditions that Galileo Galilei had 400 hundred years ago. Today experimenters who want to successfully complete an industrial project must also follow these testing procedures.

The following seven points explain the motivation behind the creation of this product:

- 1) The limited sensitivity to external noise and the efficiency are directly related to the area within the perimeter of the antenna. This promoted the use of a circular form which allows the maximum area enclosed within the perimeter (in our case, the circumference).
- 2) The efficiency of the **LOOP ANTENNA** can be calculated using the formula:

$$\text{Efficiency \%} = \frac{\text{Radiation Resistance in } \Omega}{\text{Radiation Resistance + Resistive loss in } \Omega} \times 100$$

It is easy to understand that as the resistive loss approaches zero, the efficiency of the antenna approaches 100%. In order to increase the antenna efficiency (and also its skin effect and robustness), it was decided to adopt different diameters/thickness for the aluminum tubes, based on the antenna's model and dimension. The diameter/thickness dimensions of the aluminum tubular elements are 50 x 2mm (1.9in x .08in) **Baby**, 75 x 2mm (2.9in x .08in) **Mini**, and 140 x 5mm (3.5in x .2in) **Maxi**.

- 3) High efficiency for small-dimensioned antennas, as the **LOOP ANTENNA**, means an elevated Q factor. This means that the tuning capacitor terminal has high voltage and covers a relatively smaller **tuned** portion of the spectrum but (**much more important**) the antenna itself acts as a **highly efficient PRESELECTOR**, rejecting the unwanted signals and avoiding to overcharge the receiver (or transceiver) antenna input.
  - a) The use of the vacuum variable capacitor was eliminated because of the high cost of such a device with respect to total cost of the antenna;
  - b) Instead, a variable capacitor using air as a dielectric was adopted. The variable capacitor has two packs of blades that are welded on the top of the loop on each side of the semi-loop. The two packs of blades do not touch each other and are separated by air (**1mm/1kv**)\*. The packs of blades are operated remotely by an actuator. With blades completely open, minimum capacitance exists (high frequency); with blades fully closed, maximum capacitance exists (lower frequency).

\***Note:** The reported specifications are **three times safer** than those recommended by the ARRL Book Antenna, **1mm/3kv**.





This variable capacitor consists of two packs of blades. These blades are entering one into another like a very big air variable capacitor;

c) The remote control of the variable capacitor operates at a low voltage with two different tuning speeds: one high speed for quick tuning in the Mhz range and one which is step by step for precise tuning. These speeds permit a precise tuning of the **LOOP ANTENNA** to obtain the maximum rejection of undesired signals and maintain the highest efficiency (see diagram on page 45).

- 4) The operator must be provided with every possible electrical and mechanical detail so that the installation of the **LOOP ANTENNA** is simple and clear. The only remaining points are the selection of the installation site and selection of an adequate **LOOP ANTENNA** mast. The mast must be firmly anchored. Every **LOOP ANTENNA** has a galvanized mounting clamp which accepts different mast diameters (see mechanical specifications pages 14-16) depending on the antenna model.
- 5) In order to ensure the best contact a flexible stainless steel blade is attached to the center in the bottom side of the **LOOP ANTENNA**.  
This also ensures adequate movement at the top ends where the variable capacitor is located. In the two bigger **LOOP ANTENNA** models, for shipping reason, four tubular arch sections are used. These sections are joined using flanges with precision groove, which hermetically seals the anti-oxidant paste (provided).
- 6) The **LOOP ANTENNA** can be installed at different heights from the ground and still provide superior results. This is because of a particular gamma-match of 50 ohms. This ensures the best irradiating signal at every elevation angle and guarantees the communication to both near and far.
- 7) There are only three **LOOP ANTENNA** models that cover the HF span from 1.750 Mhz to 29.800 Mhz. The chart below reports the denominations, the diameter, and the frequency coverage of each of the three models:



Baby	- Ø 1 m (3.28 ft)	from 6.600 to 29.800 MHz
Mid	- Ø 2 m (6.56 ft)	from 3.500 to 14.500 MHz
Maxi	- Ø 4 m (13.12 ft)	from 1.750 to 7.300 MHz



## Materials selection

The best materials available were chosen to enforce the seven points stated above as well as to guarantee robustness, defense against natural elements, durability and highest efficiency of the antenna. The following describes the materials selected for each type of **LOOP ANTENNA**:

- a) - tubular element made of aluminum alloy 60/60
  - Ø 50 x 2 mm thickness (1.9 in x .08 in) for model **Baby**, Net Weight 16 Kg (26.5 lbs) including mounting clamp
  - Ø 75 x 2 mm thickness (2.9 in x .08 in) for model **Mini**, Net Weight 20 Kg (44.1 lbs) including mounting clamp
  - Ø 140 x 5 mm thickness (5.5 x 0.2 in) for model **Maxi**, Net Weight 105 Kg (231.5 lbs) including mounting clamp
- b) - stainless steel bolts and holding pin for the semi-loop bottom part of the **LOOP ANTENNA**.
  - This pin rests on a friction bearing (for the **Maxi**, the pin rests on ball bearings).
- c) - Teflon guide for variable capacitor blades
- d) - Galvanized steel mounting clamp
- e) - Actuators (provided with shield and RF filters):
  - 8 inches, 36 volts for model **Baby**
  - 10 inches, 36 volts for model **Mini**
  - 24 inches, 36 volts for model **Maxi**
- f) - Remote Loop Controller for tuning using a **microprocessor** and an **alphanumeric dot matrix display**. Unit powered by a 110V-240V AC source (24 V DC available on request).
- g) - User-friendly **modified mouse** for the loop controller.

Examine the antenna's net weight (which includes the mounting clamp) to confirm that the robustness was a constant in the design and construction of the antenna.



### Mechanical assembly

Specialized equipment was used to correctly shape the aluminum tubular elements to guarantee the structural integrity of the **LOOP ANTENNA**.

The extensive use of T.I.G. welding (Tungsten with Injection of Gas) was used to ensure optimal contact and robustness (fig. 1).

The only movable (for few degrees only) section of the loop is at the bottom. The specially shaped blade, made of stainless steel, is anchored on each semi loop using three stainless steel bolts. It is recommended that the provided anti-oxidant paste is used before turning the bolts.

The pivot pin of the mobile semi-loop is made of stainless steel and is installed in a friction bearing. In the **M<sub>axi</sub>** model, self-centering ball bearings are used.

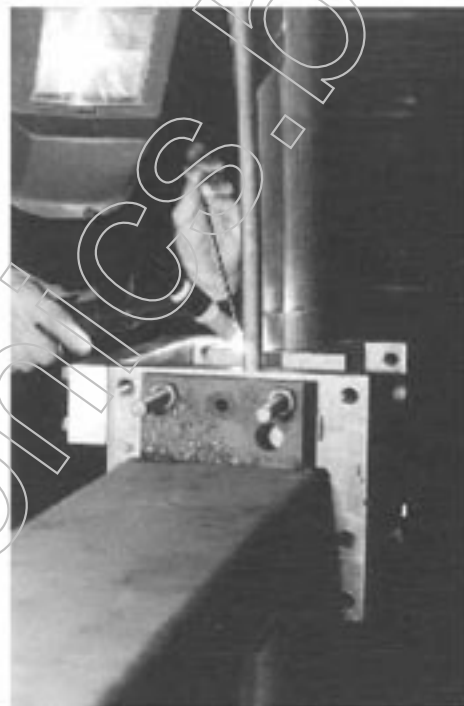


fig. 1

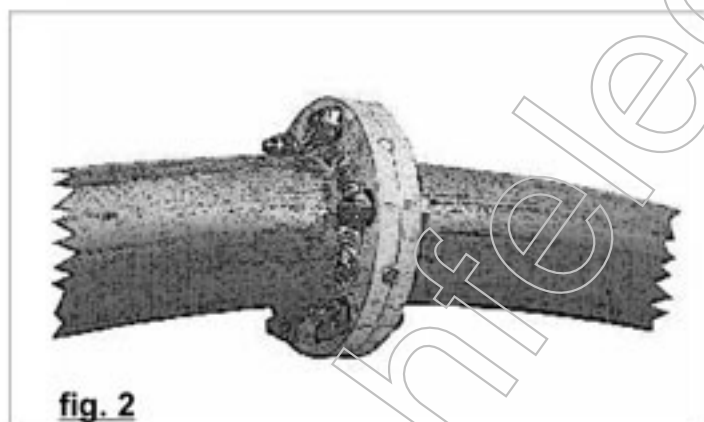


fig. 2

The two big **LOOP ANTENNA** are made of four sections (fig. 2).

To ensure contact between these sections, precision grooved flanges are used. These hermetically sealed grooves are filled with anti-oxidant paste (provided).

In the **M<sub>idi</sub>**, each couple of flanges are joined using 6 stainless steel bolts. In the **M<sub>axi</sub>**, 8 stainless steel bolts are used. The galvanized mounting clamp can be used in a mast of  $\varnothing 60 - 75\text{mm}$  (2.4 - 3.0in) for the **B<sub>aby</sub>** and **M<sub>idi</sub>** models, and in a mast of  $\varnothing 90 - 114\text{mm}$  (3.5 - 4.5in) for the **M<sub>axi</sub>** model.

The maximum attention was given to be sure that the **LOOP ANTENNA** would be able to withstand the rigors of adverse climatic conditions and wind pressure. (\*)

(\*) Every part of the antenna is subjected to severe testing before it is shipped to the customer.



### Packaging Technique

A personal computer and CAD (Computer Aided Design) were used extensively.

Each part of the packaging was designed and tested for the most severe conditions.

Various types of cardboard and wood are used to pack the **LOOP ANTENNA** for delivery to the customer.

The chart below outlines the packaging strength represented by the difference between gross and net weights:

fig. 5



Model	Net Weight	Gross Weight	Difference
Baby	kg. 16 ( 35.27 lbs)	kg. 26 ( 57.32 lbs)	kg. 10 (22.04 lbs)
Midi	kg. 20 ( 44.09 lbs)	kg. 32 ( 70.54 lbs)	kg. 12 (26.45 lbs)
Maxi	kg. 105 (231.43 lbs)	kg. 130(286.60 lbs)	kg. 25 (55.11 lbs)



Please notice that the weight difference of the biggest model is much larger than the others, 25 kg (55.11lbs). This is because of the large amount of wood used to pack and protect the big structure of the variable capacitor blades (see fig.15 and 46). The rest, specifically the four tubular elements of the loop, are shipped separately, and are covered in a protective plastic material.

Sometimes, even the best shipping materials cannot completely protect the package from accidents, so please inspect the contents before accepting the shipment.

fig. 6

## Electrical / mechanical specifications and sketch of Baby

### Electrical specifications

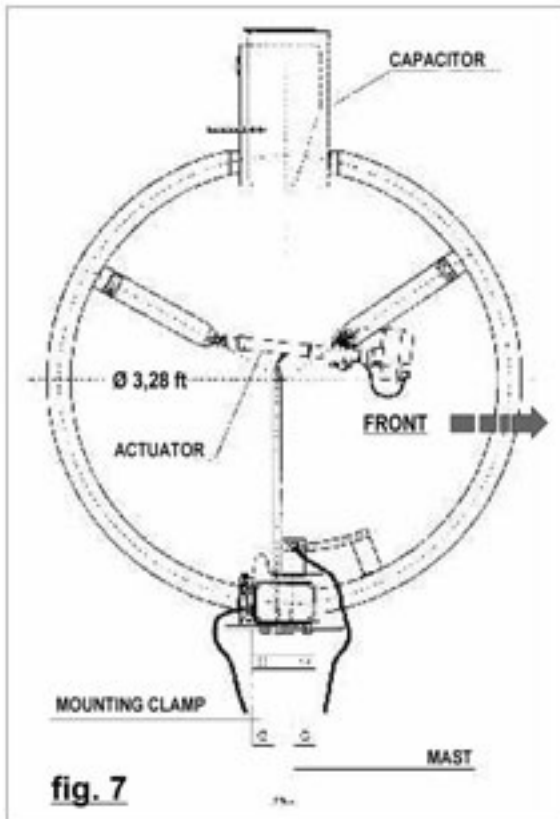


fig. 7

- ➔ Continuous frequency Range: 6.600 – 29.800 MHz
- ➔ S.W.R: 1.3:1 Typical
- ➔ Front to Back Ratio: 6 dB
- ➔ Front to Side Ratio: 25 dB
- ➔ 50 Ohm input impedance with gamma match short circuited (electrostatic discharge protection)
- ➔ Negligible noise and harmonics
- ➔  $L = 3 \mu\text{H}$   $Q = 1.100$  at 7 MHz
- ➔  $C = 400 \text{ pF}$  at 17 KV r.m.s.
- ➔ Power Rating: 450W up to 21.0 MHz \*\*  
1kW 22.0 - 29.8 MHz \*\*
- ➔ Bandwidth: 4 KHz @ 7.0 MHz  
6 KHz @ 14.0 MHz  
12 KHz @ 21.0 MHz  
20 KHz @ 28.0 MHz
- ➔ Gain compared to  $\lambda/2$  dipole (1 "S" point = 6 dB):  
-4 dBd @ 7.0 MHz  
-0.3 dBd @ 28.0 MHz

**\*\*NOTE:** With this LOOP ANTENNA the peak power is equal to the continuous power.

### Mechanical specifications

- ➔ Antenna Diameter: 1 m (39.8 in)
- ➔ Aluminum alloy 60/60 welded with Tungsten and Injection of Gas
- ➔ Tubular Element  $\varnothing 50 \text{ mm} \times 2 \text{ mm}$  thickness (1.9 in x .08 in)
- ➔ All stainless steel hardware and support pin
- ➔ Galvanized Mounting clamp for a mast of  $\varnothing 60 \text{ mm} \varnothing 76 \text{ mm}$  (2.4 in – 3.0 in)
- ➔ Net/Gross Weight 16 Kg / 26 Kg (26.5 lbs – 57.3 lbs)
- ➔ Windload  $0.25 \text{ m}^2$  (2.7 ft<sup>2</sup>)
- ➔ Maximum supported wind velocity 161 km/h (100 mph)
- ➔ Force exerted on antenna by wind of 129 km/h (80.15 mph) = 480 N
- ➔ Maximum flexibility moment on the antenna base anchoring point to a metal mast  $\varnothing 6 \text{ cm}$ , height 3 m ( $\varnothing 2.36 \text{ in}$ , height 9.84 ft) = 720 N/m

NOTE: C.E.I. regulations require the installation of a wind-guys for areas of high wind with possible iceformation. (in this case NON metallic guys)

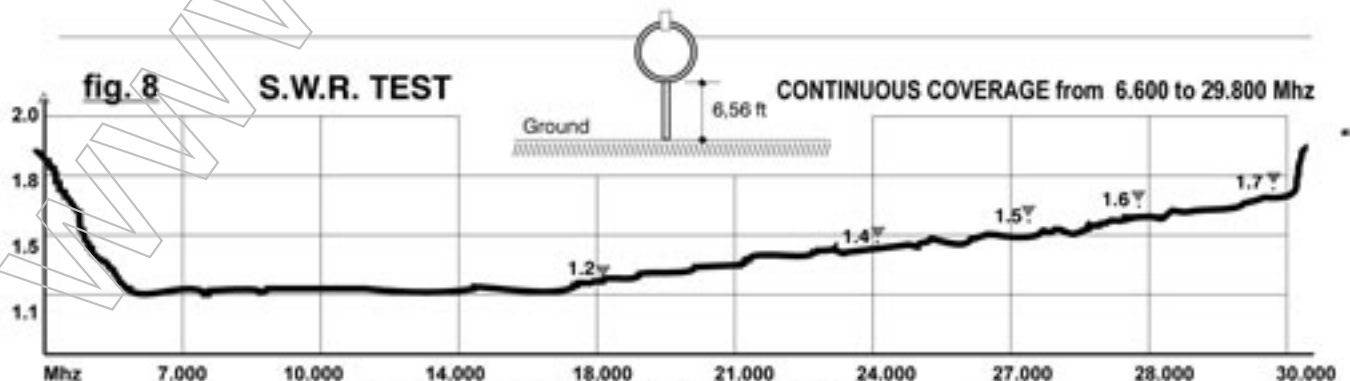


fig. 8

### S.W.R. TEST



**Electrical / mechanical specifications and sketch of Mid**

**Electrical specifications**

- ➔ Continuous frequency Range: 3.500 – 14.500 MHz
- ➔ S.W.R: 1.2:1 Typical
- ➔ Front to Back Ratio: 6 dB
- ➔ Front to Side Ratio: 25 dB
- ➔ 50 Ohm input impedance with gamma match short circuited (electrostatic discharge protection)
- ➔ Negligible noise and harmonics
- ➔ L = 4.5 μH      Q = 1.500 at 3.5 MHz
- ➔ C = 560 pF at 14 KV r.m.s.
- ➔ Power Rating: 300W 3.5 – 7.0 MHz\*\*  
800W 8.0 – 14.5 MHz\*\*
- ➔ Bandwidth: 4 KHz @ 3.5 MHz  
6 KHz @ 7.0 MHz  
10 KHz @ 14.0 MHz
- ➔ Gain compared to 1/2λ dipole( 1 "S" point = 6 dB):  
-4 dBd @ 3.5 MHz  
-0.3 dBd @ 14.0 MHz

**\*\*NOTE:** With this LOOP ANTENNA the peak power is equal to the continuous power.

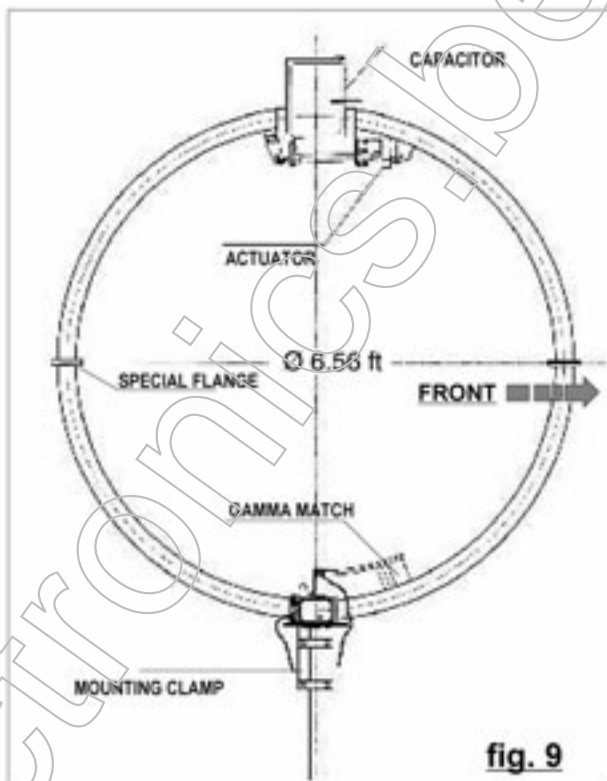
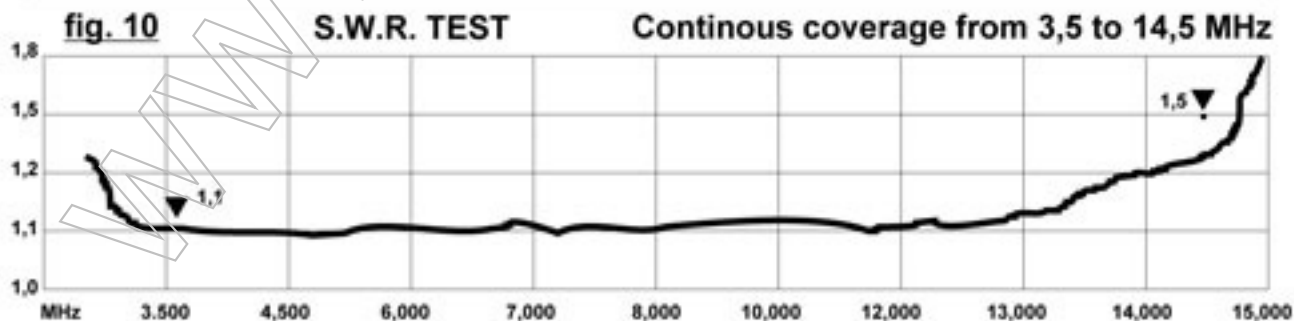


fig. 9

**Mechanical specifications**

- ➔ Antenna Diameter: 2 m (78.7 in.)
- ➔ Aluminum alloy 60/60 welded with Tungsten and Injection of Gas
- ➔ Tubular Element Ø 75 mm x 2 mm thickness (Ø2.9 in x .08 in)
- ➔ All stainless steel hardware and support pin
- ➔ Galvanized Mounting clamp for a mast of Ø 60 mm – 76 mm (2.4 in – 3.0 in)
- ➔ Net / Gross Weight 20 Kg / 32 Kg (44.1 lbs – 70.5 lbs)
- ➔ Windload 0.5 m<sup>2</sup> (5.38 ft<sup>2</sup>)
- ➔ Maximum supported wind velocity 161 km/h (100 mph)
- ➔ Force exerted on antenna by wind of 129 km/h (80.15 mph) = 480 N
- ➔ Maximum flexibility moment on the antenna base anchoring point to a metal mast Ø 6 cm, height 3.5m (Ø2.36in, height11.48 ft) = 1.680 N/m

Note: C.E.I. regulations require the installation of a wind-guys for areas of high wind with possible ice formation (in this case **NON** metallic guys).



## Electrical / mechanical specifications and sketch of Maxi

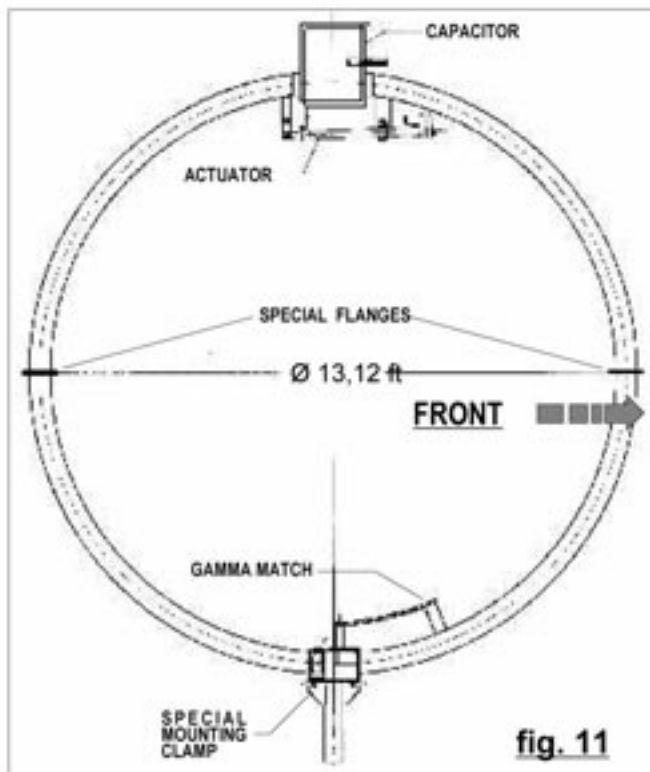


fig. 11

### Electrical specifications

- ➔ Continuous frequency Range: 1.750 – 7.300 MHz
- ➔ S.W.R: 1.1:1 – 1.5:1 Typical
- ➔ Front to Back Ratio: 6 dB
- ➔ Front to Side Ratio: 25 dB
- ➔ 50 Ohm input impedance with gamma match short circuited (electrostatic discharge protection)
- ➔ Negligible noise and harmonics
- ➔  $L = 8 \mu\text{H}$   $Q = 1,500$  at 1.8 MHz
- ➔  $C = 1,400 \text{ pF}$  at 22 KV r.m.s.
- ➔ Power Rating: 700W 1.750 – 6.000 MHz \*\*  
2 KW 7.000 – 7.300 MHz \*\*
- ➔ Bandwidth: 4 KHz @ 1.8 MHz  
6 KHz @ 3.5 MHz  
8 KHz @ 7.0 MHz
- ➔ Gain compared to  $\frac{1}{2} \lambda$  dipole (1 "S" point = 6 dB):  
-4 dBd @ 1.8 MHz  
-0.3 dBd @ 7.0 MHz

\*\*NOTE: With this LOOP ANTENNA the peak power is equal to the continuous power.

### Mechanical specifications

- ➔ Antenna Diameter: 4 m (13.12 ft)
- ➔ Aluminum alloy 60/60 welded with Tungsten and Injection of Gas
- ➔ Tubular Element  $\varnothing 140 \times 5$  mm thickness (5.5in x 0.2 in)
- ➔ All stainless steel hardware and support pin resting on ball bearing.
- ➔ Galvanized Mounting clamp for a mast of  $\varnothing 90 - 114$  mm (3.5 – 4.5 in)
- ➔ Net/Gross Weight 105/130 Kg (231.5 – 286.6 lbs)
- ➔ Windload  $2.2 \text{ m}^2$  (23.7  $\text{ft}^2$ )
- ➔ Maximum supported wind velocity 161 km/h (100 mph)
- ➔ Force exerted on antenna by wind of 129 km/h (80.15 mph) = 2.112 N
- ➔ Maximum flexibility moment: on the antenna base anchoring point to a metal mast  $\varnothing 14$  cm, height 4.5m ( $\varnothing 5.5$ in, height 14.76ft) = 10.560 N/m

Note: C.E.I. regulations require the installation of a wind-guys for areas of high wind with possible ice formation (in this case NON metallic guys).

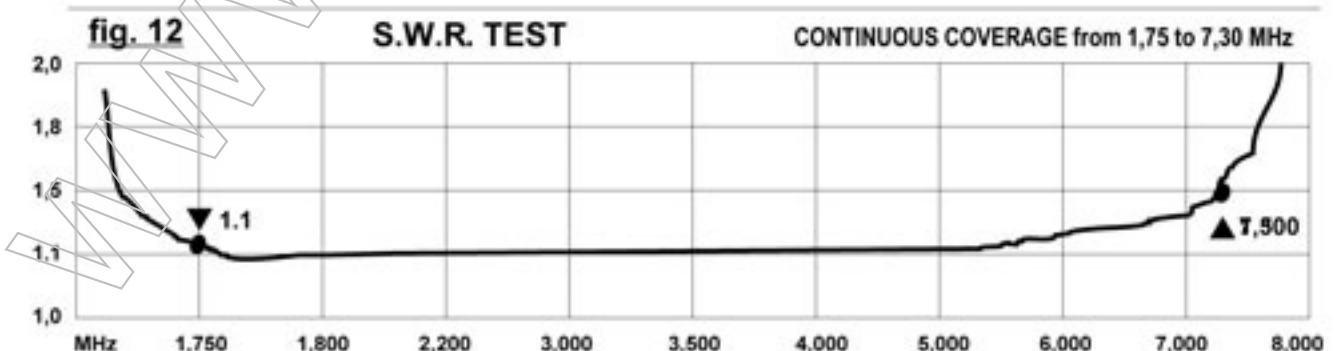


fig. 12

S.W.R. TEST

CONTINUOUS COVERAGE from 1,75 to 7,30 MHz



**SECTION II**

[www.hfelectronics.be](http://www.hfelectronics.be)





## B<sub>aby</sub> packaging contents

Item	Description	Quantity
0101	Antenna ready for the installation	1
0102	Zinc plated steel mounting clamp and hardware	1
0106	Accessory box containing: 1 loop controller 1 mouse(modified) 1 Presentation and Instruction Manual	1

fig. 13

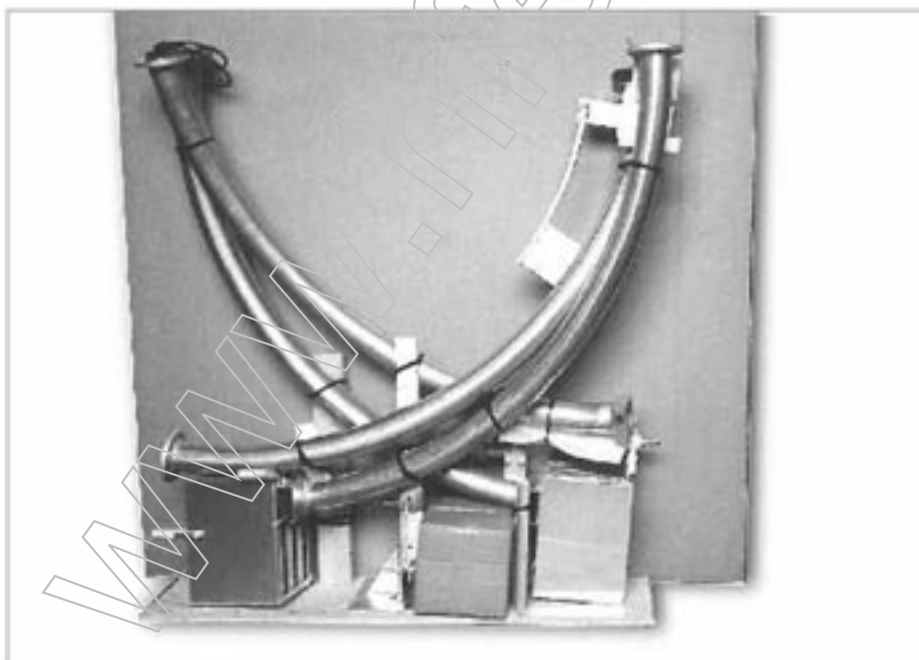


**Note:** The B<sub>aby</sub> antenna arrives already assembled. Connect the power cable and the



### Midi packaging contents

Item	Description	Quantity
0204	Tubular section with flange and friction bearing	1
0206	Tubular section with flange and variable capacitor pack blades	1
0208	Tubular section with flange, pack of blades and actuator with motor	1
0210	Tubular section with flange, base container and gamma match	1
0212	Zinc plated mounting clamp with hardware	1
0218	<u>Box containing:</u>	
	Loop controller	1
	Modified mouse	1
	Antioxidant paste	1
	Bolts M 12 x 30	4
	Washers	4
	Stainless steel pivot pin 18 x 120	1
	Stainless steels screw M 10 x 25 flared head	2
	Stainless steel washes Ø 14	2
	Stainless steel bolts M 8 x 12	3
	Stainless washes Ø 8	3
	Stainless bolt M 8 x 40	1
	Presentation and Instruction Manual	1



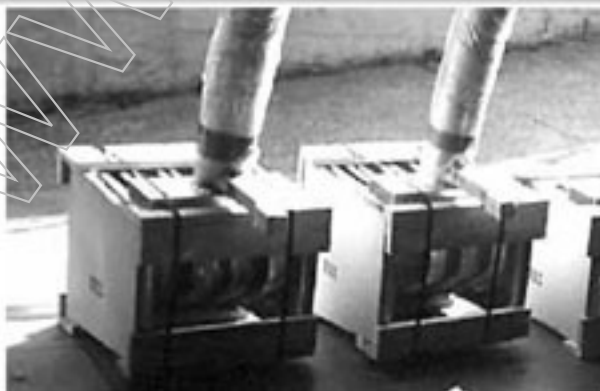
\*Picture of the Midi right after removing it from the shipping package.

fig. 14



## Maxi packaging contents

Item	Description	Quantity
<b><u>Flange assembly</u></b>		
09025	Stainless bolts M10 x 35	16
09015	Stainless self-locking nut M10	16
09019	Stainless washes Ø 10	16
	Antioxidant paste	01
<b><u>Ball bearing assembly</u></b>		
09010	Ball bearing with self-centering support Model SKF FYTB 25 TF	02
09011	Stainless pivot pin 25 x 267	01
09020	Stainless bolts M10 x 50 (ball bearing locking)	04
09015	Stainless self-locking nut (ball bearing locking)	04
09012	Stainless bolt M10 x 15 (pivot pin locking)	02
09013	Stainless large washes (pivot pin locking)	02
09004	Stainless bolts M 8 x 30	09
09005	Stainless flexible blade	01
<b><u>Blades guide assembly</u></b>		
09001	Blade guide with teflon skid	02
09002	Stainless bolts flared head M 6 x 25	04
09003	Stainless self-locking nut Ø 6	04
09000	Stainless plate blades guide	02
<b><u>Actuator piston locking</u></b>		
09014	Stainless bolt M10 x 70	01
09015	Stainless self-locking nut M10	01
09019	Stainless washes Ø 10	02
<b><u>Antenna installation on the base</u></b>		
09021	Zinc plated bolts M 14 x 40	04
09022	Zinc plated bolts M 14 x 60	02
09023	Zinc plated self-locking nuts M 14	06
09024	Zinc plated washes Ø 14	06
	<b>Presentation and Instruction Manual</b>	01



\*The photo shows the packs of blades packaged separately in a wood container.

**fig. 15**



**SECTION III**

[www.hfelectronics.be](http://www.hfelectronics.be)



## Where to install (preferably) the LOOP ANTENNA

This antenna has the ability to receive and transmit practically from any place. It was tested on the ground, installed on a house balcony and even on a house attic (away from people and other equipment), with good results.

However, it is preferable to find a site where the elevation radiation pattern is not obstructed, guaranteeing communication at short, medium and long distances.

Based on many experiments conducted, it is recommended that the **LOOP ANTENNA** be installed as follows:

- 1) Away from metallic structures – or metal encased in cement - at least 2-3 meters (6.56 - 9.84 ft)
- 2) Minimum height from ground (or flat surface) equal to the antenna diameter plus 50cm (1.64ft)

The following are recommended heights for the various models:

- at least 1.5 m ( 4.92 ft) for the **Baby**
- at least 2.5 m ( 8.20 ft) for the **Midi**
- at least 4.5 m (14.76 ft) for the **Maxi**

Additional height does not cause concern. In the case of the **Midi** model (only), there is a setting of the **Gamma Match** to obtain the lowest S.W.R. (see fig. 43 and 44).

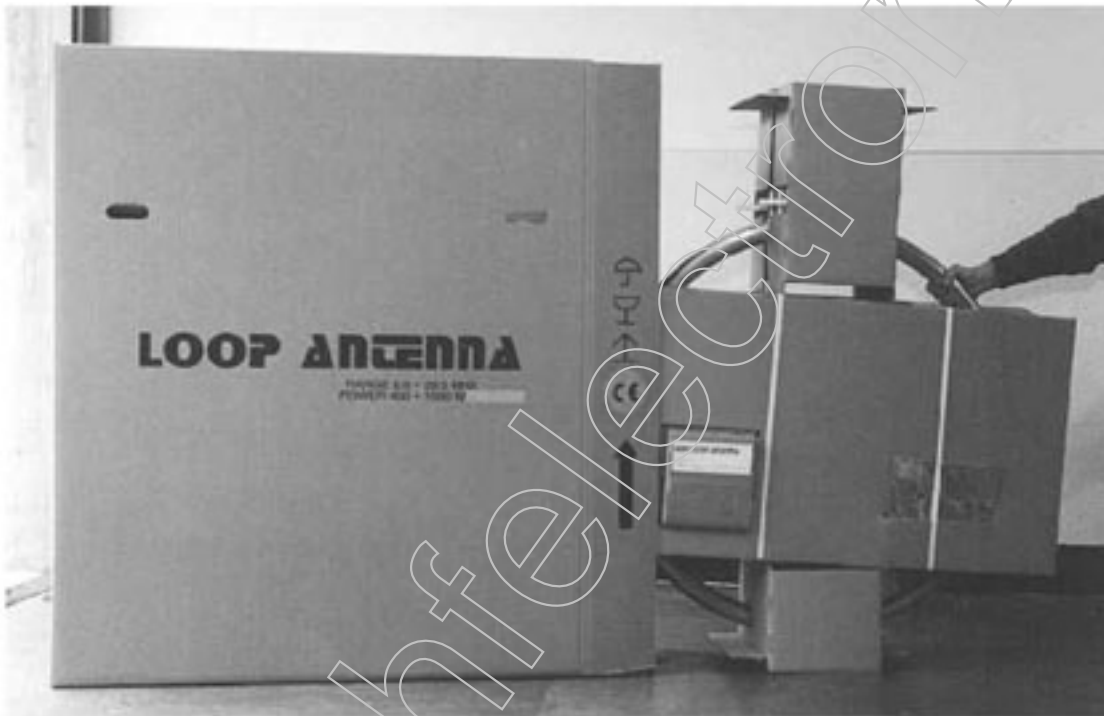
- 3) For safety reasons, the antenna should not be installed near electrical cables, even low voltage, or telephone cables.
- 4) For safety reasons, verify that the antenna mast is grounded according to electrical local code.
- 5) For safety reasons, verify that nobody comes in direct or indirect contact through cables, poles or other electrical conductive objects **during transmission (only, of course)** sessions. Dangerous levels of voltage exist within the blades of the variable capacitor.
- 6) It is strongly recommended NOT to operate the **LOOP ANTENNA** in the same room where the transmitter and operator are located.



## Assembly of the LOOP ANTENNA Baby

Of the three **LOOP ANTENNA** models, the **Baby** is the easiest to install. Due to its reduced dimensions, the antenna can be shipped pre-assembled to the customer. The only required assembly is the connection of the coaxial cable, connection of the electrical cable to the actuator, and connection of the actuator sensor cable to the loop controller.

The following pictures help in the installation process.



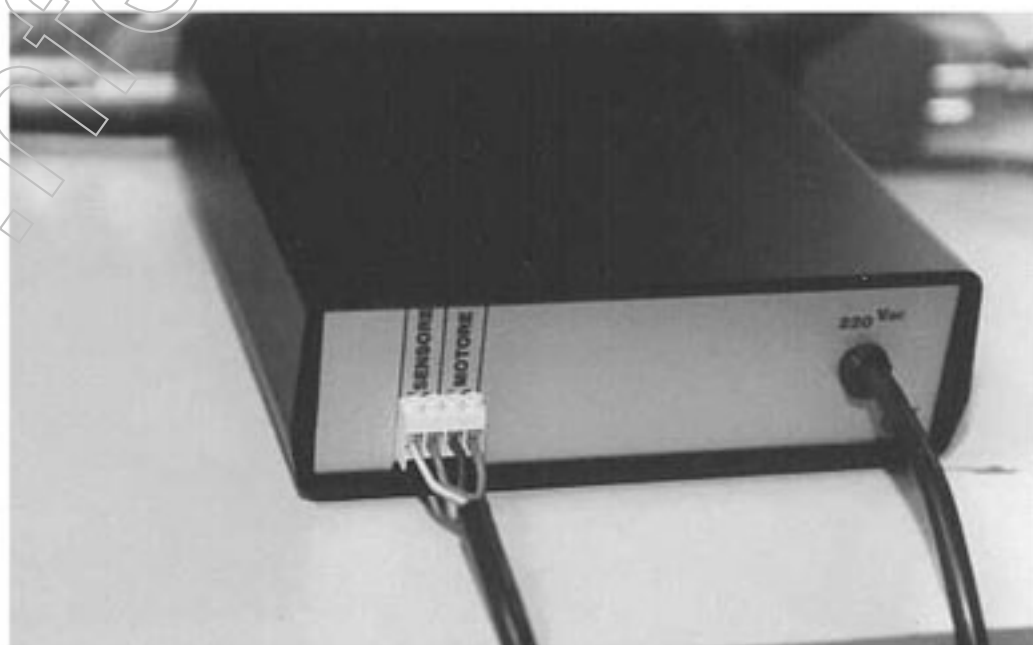
**fig. 16**

**\*The Baby shipping container includes all the items necessary for the installation. The same container also houses the Loop Controller, the mounting clamp and the Presentation and Instruction Manual.**

**The picture shows the correct way to remove the antenna from the container after opening from the indicated side.**



\* Carefully observing the wire color, connect the cable to power actuator in the back of the Loop Controller. Error can cause severe sensor damage. (See manual page 40).



**fig. 18**



## Assembly of the LOOP ANTENNA *M*<sub>idi</sub> and *M*<sub>axi</sub>

Following are assembly descriptions of the **LOOP ANTENNA** *M*<sub>idi</sub> and *M*<sub>axi</sub> models. These two models can be considered as being from the same family even if they differ in size and particular characteristics. The following pictures will help to assemble the *M*<sub>idi</sub> model:



fig. 19

Loop Controller container, (see page 19)

The *M*<sub>idi</sub> removed from the cardboard box. The four sections will make up the two antenna semi-loops. The two top sections come with the variable capacitor pack blade already welded. In the small box (located between the capacitor pack blades) is the Loop Controller, the mounting clamp and necessary hardware.





fig. 20

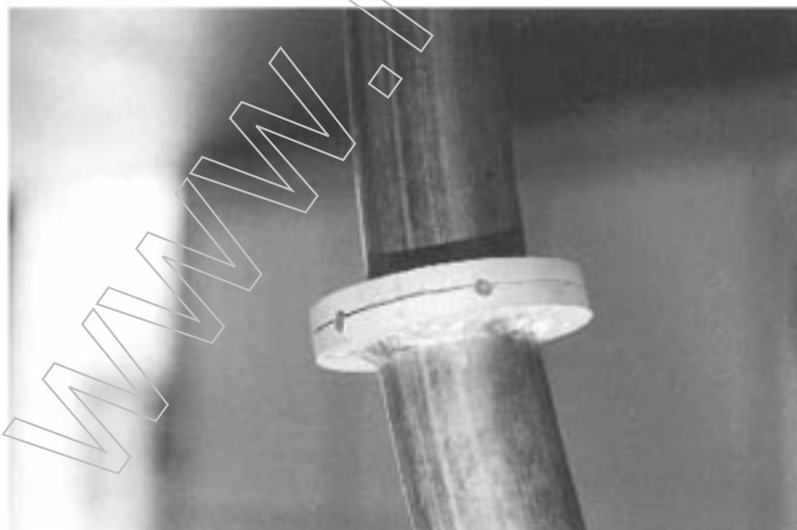
### Semi-loop assembly

\*The first step is to join the two arch sections (which will form the semi-loop) done by fitting together the two precision flanges.

\*Spread the provided antioxidant paste on the flange's circular groove.

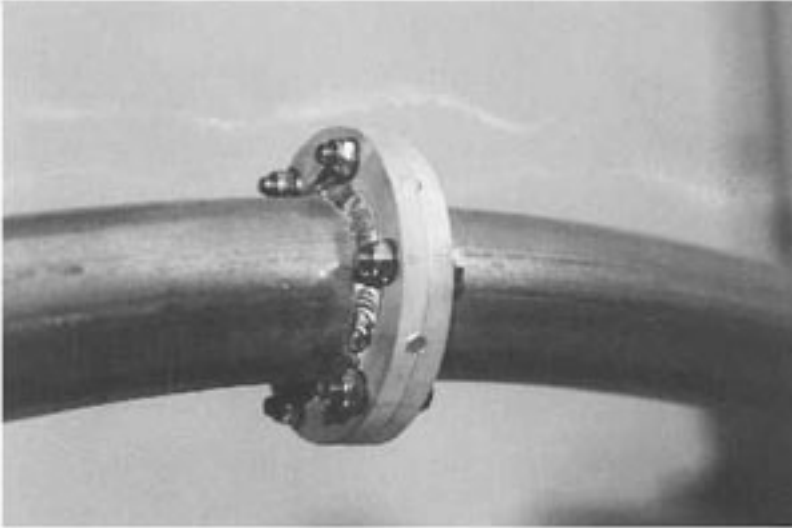


fig. 21



\*Then, unite the two semi-loops' parts insuring that the two flanges' guides are perfectly matched.

fig. 22



\* Tighten the two flanges using the stainless bolts and self-locking nuts.

**fig. 23**



**fig. 24**

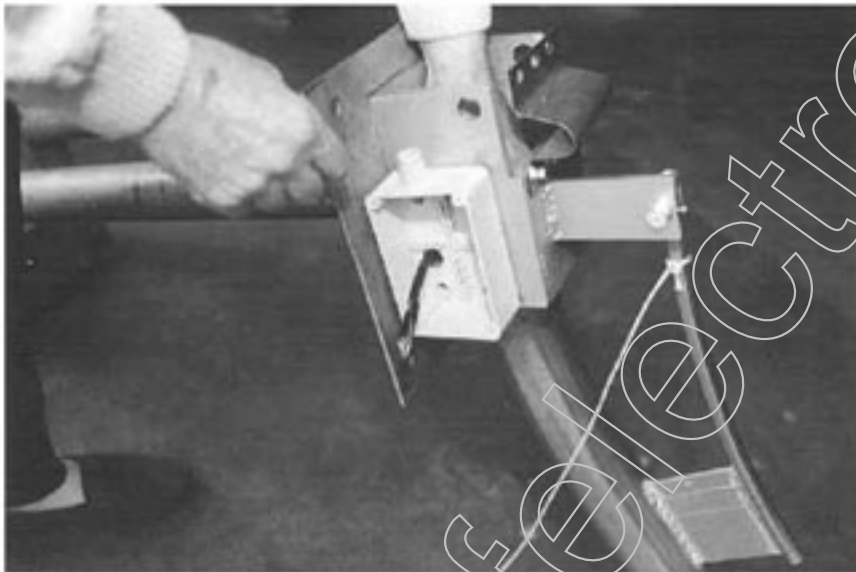
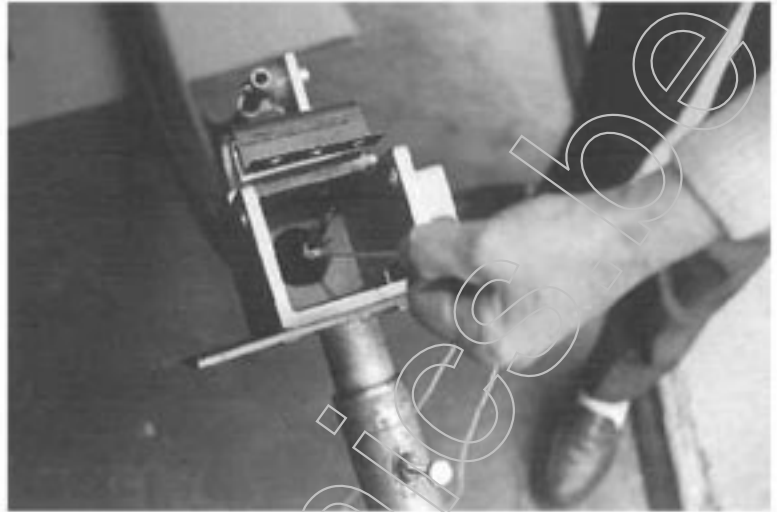


**fig. 25**

\* The same operation is required to assemble the other semi-loop. Before joining the second antenna semi-loop, it is necessary to feed the actuator power line through the two aluminum tubes and flanges. This can be done by hooking the power line to the string already inside the tube. (see fig. 24 and 25)

**\*Pull the full length of the power cable through the tubes, then push it through the hole in the zinc plated base, into the distribution box.**

**fig. 26**



**fig. 27**

**\*The actuator power cable is shown on the left. The box in the picture hosts the cable terminal strip and the RF filter.**

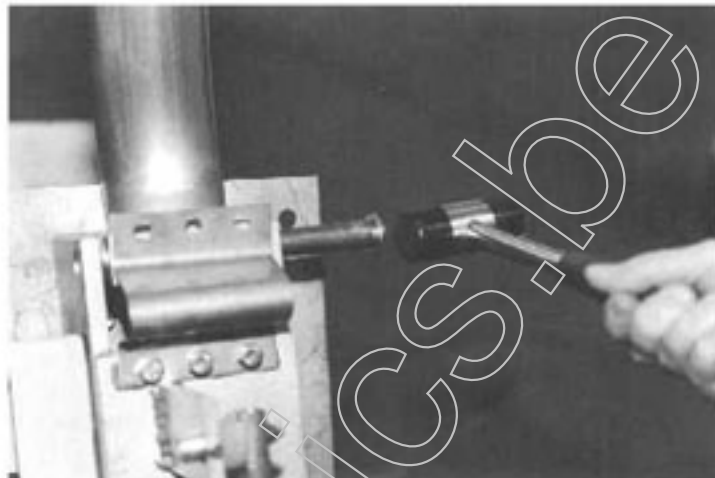
**\*After spreading the antioxidant paste in the grooved flange, unite the flanges and install the bolts and nuts.**

**fig. 28**

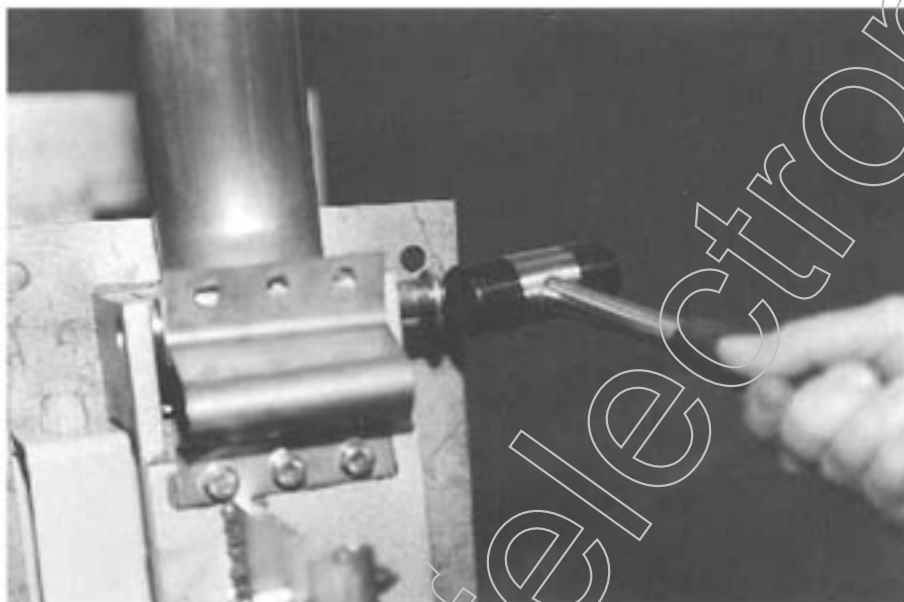




\* Place the bottom section of the semi-loop (with the housed friction bearing) on the base plate. Then, insert the steel pin which will allow the top of the semi-loop to swing a few degrees.



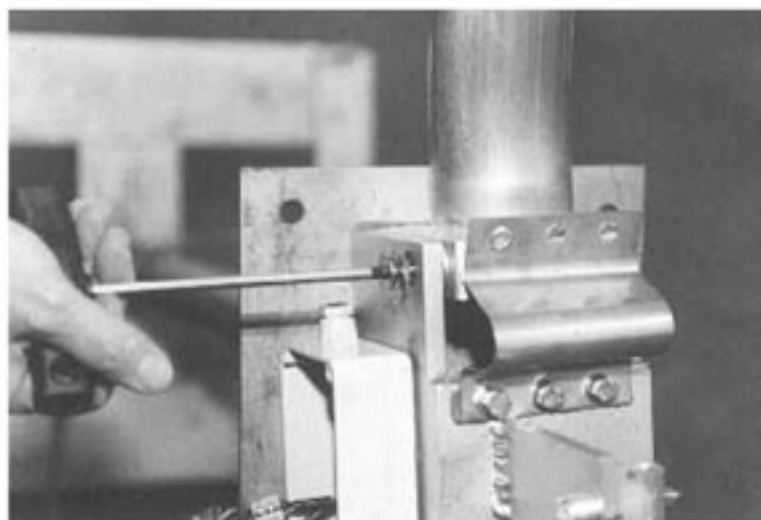
**fig. 29**



\* Using a plastic hammer, fully insert the pin. Do not use excessive force. If necessary, gently move the semi-loop until the pin is in place.

**fig. 30**

\* After the pin is fully engaged, install the washer and the bolt, then tighten them. A 6 mm (.24 in) wrench is provided to do this operation. DO NOT forget the washer!



**fig. 31**

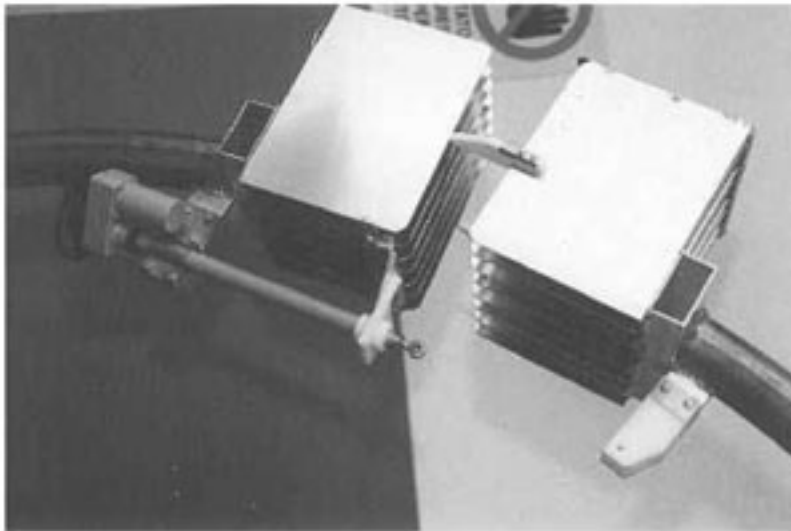


fig. 32

**\*Positioning the teflon guides (fig. 32), with both hands, fully slide the variable capacitor blades into one another. Do not bend the blades in the process.**

fig. 33

**\*With the capacitor fully closed, the piston-end will enter the receptacle in the isolated arm. This arm is anchored to the semi-loop as show in the sketch of fig. 34.**

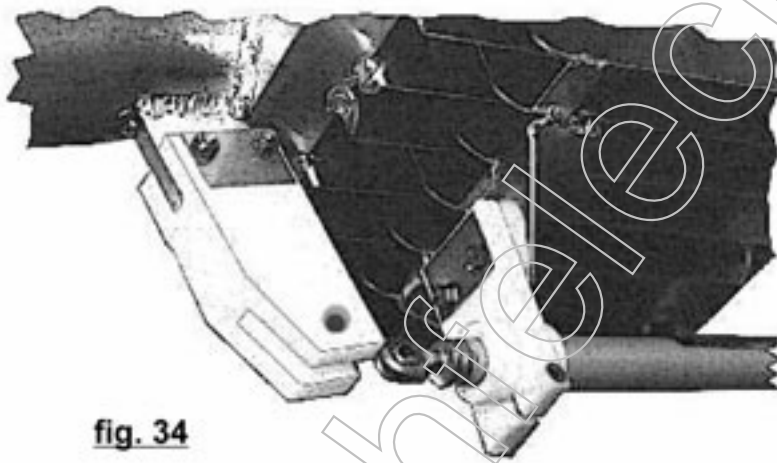
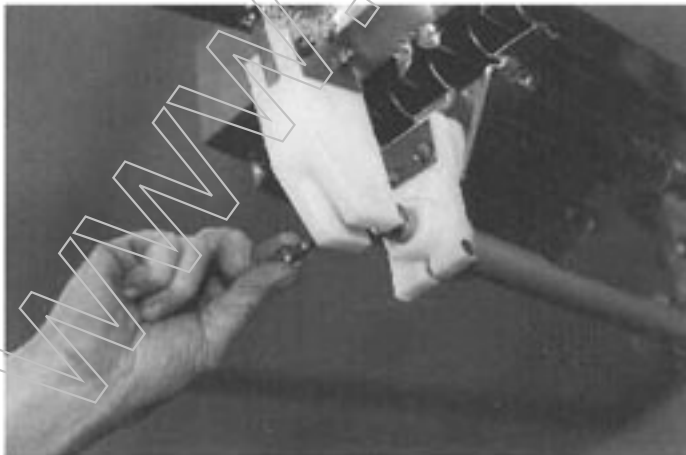
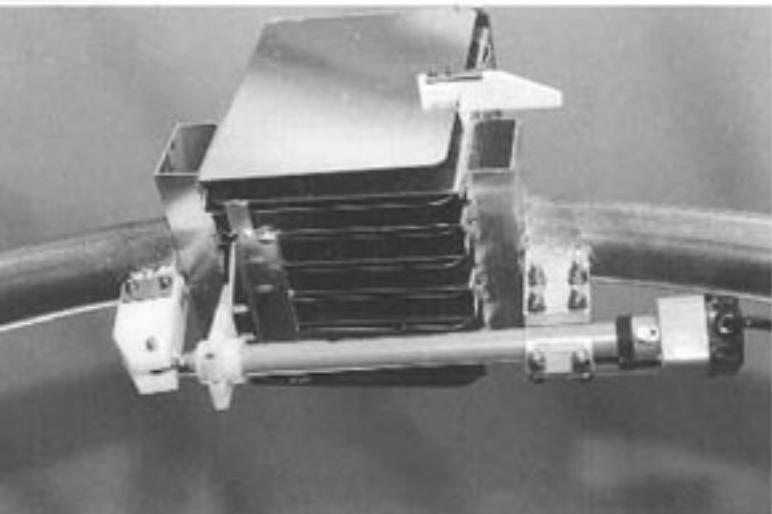


fig. 34



**\*After the piston-end is in place, install the bolt and place the self-locking stainless nut on it. Tighten the nut until it reaches the surface of the isolated arm. Do not force it.**

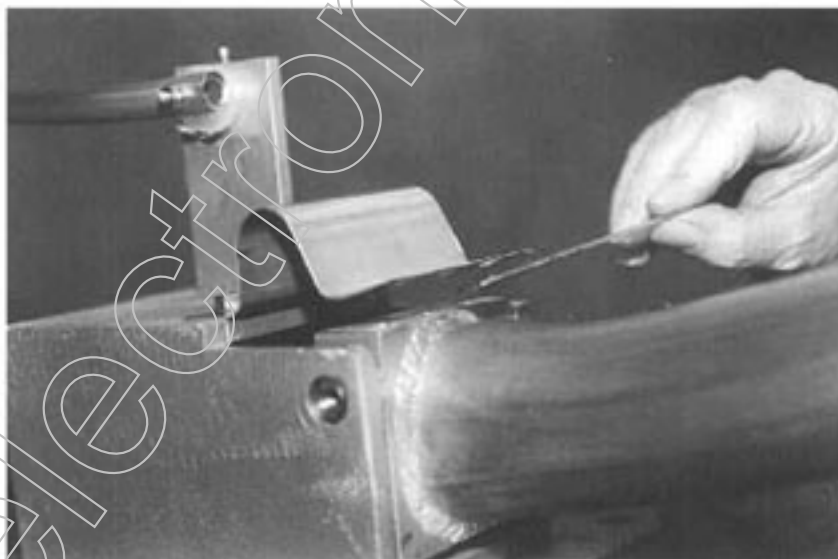
fig. 35



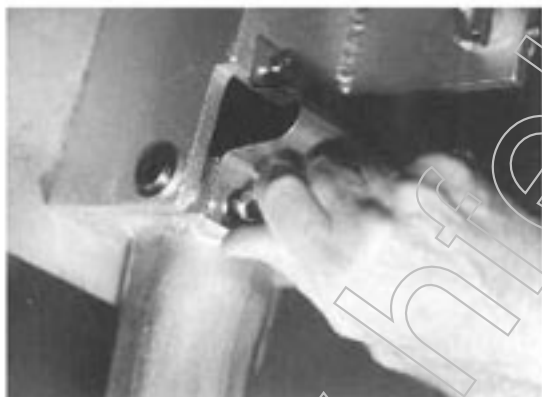
\* Fig. 36 shows the completed work. The joint piston isolated arm should not be loose. However, it's not recommended to force the components to settle in place.

**fig. 36**

\* Now connect the semi-loop junction blade. Spread the antioxidant paste provided before installing the retaining bolts.

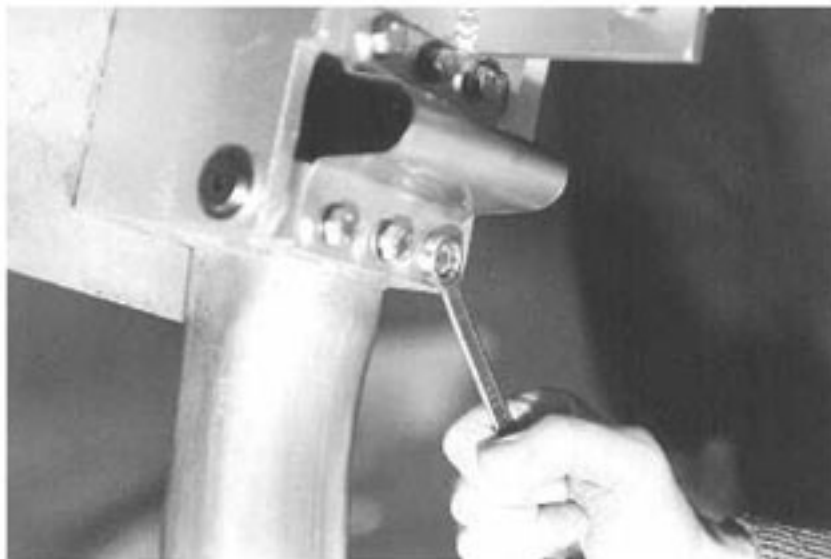


**fig. 37**



**fig. 38**

\* Install the washers and bolts then tighten them with a wrench.



**fig. 39**

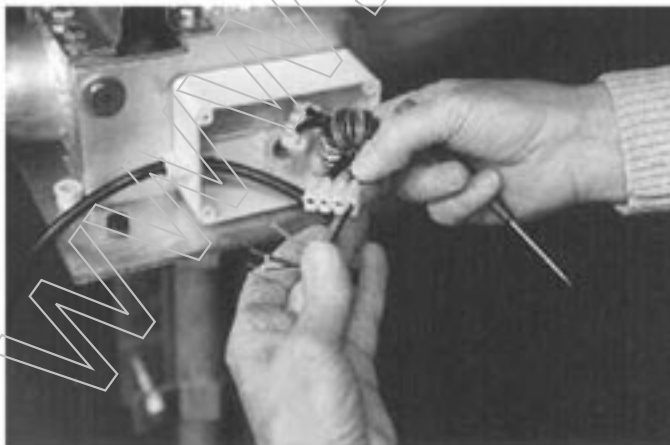
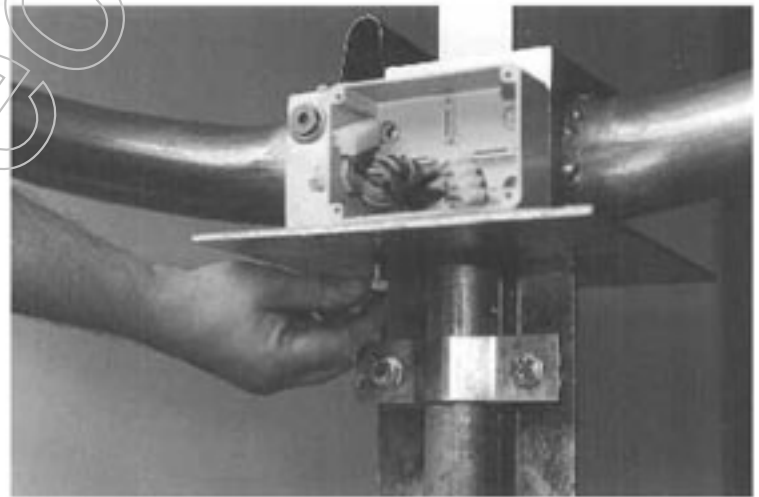


**\*Now that the LOOP ANTENNA is assembled, position it on the plate attached to the mounting clamp. The mounting clamp will be anchored to the mast as shown in fig. 40. This step requires two people. If possible the use of two people is also recommended for the previous steps.**

**fig. 40**

**\*Join the antenna to the base using the zinc plated bolts provided.**

**fig. 41**



**\*Using the connecting terminal (provided), connect the power cable from the loop controller to the cable from the actuator. The connecting terminal is equipped with an RF suppressing toroid.**

**NOTE: When connecting, match the color of the wires.**

**fig. 42**



### Adjustment (for Midi only)

Fig. 43 shows the installation of a Midi on a house roof. The gamma match calibrated at the factory for S.W.R 1:1,1 with the antenna located at 3.5 m (11.48 ft) from a flat surface.

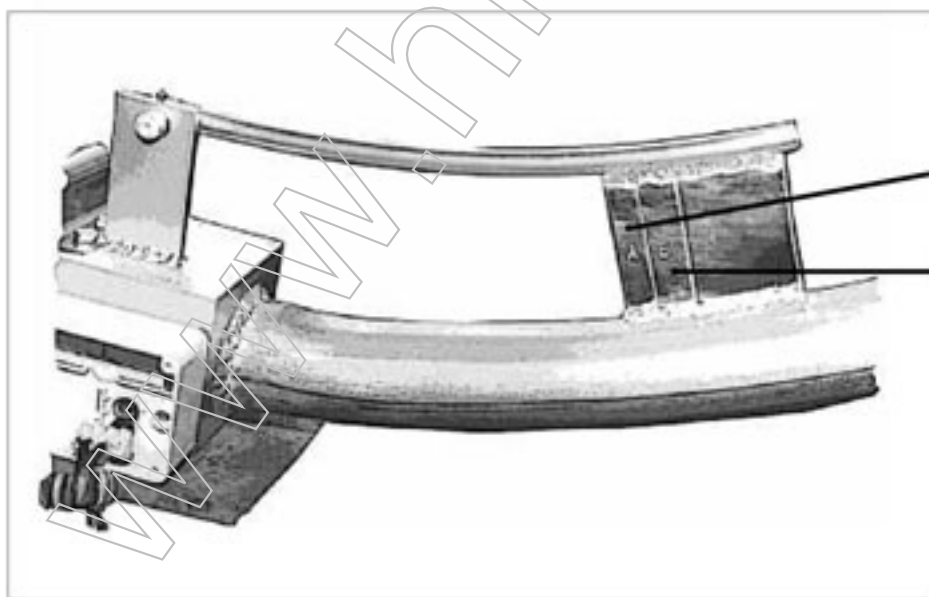
For installation below 3 m (9.84 ft), remove from the gamma match the area marked "A".

For installation below 2m (6.56 ft), remove from the gamma match the area marked "A" and "B" (see fig. 44).

The above operations are required only in case the antenna is installed on flat surface. If the antenna is not installed in any of the situations described above, refer to page 44 for instructions.



fig. 43



AREA "A"

AREA "B"

fig. 44





## Assembly of the LOOP ANTENNA M<sub>axi</sub>

The procedure for assembling the M<sub>axi</sub> is similar to the one for the M<sub>idi</sub>, except for the dimensions and the semi-loop movement pin.

In the case of the **Maxi**, the pin is installed on a ball bearing with self-centered support, due to the weight and mechanical stress. Because of the dimensions of the M<sub>axi</sub> antenna, more space and the help of a few people is required.

The following are pictures of the assembly process:



**fig. 45**

**\*Also in the case of the M<sub>axi</sub>, the semi-loops are joined using flanges. Antioxidant paste must be used at the junction of the flanges. The flanges are joined using 8 bolts. All the parts are wrapped in plastic sheets (see fig. 45).**

**NOTE:**

The iron bolts, used for shipping and joining flanges, are not to be used for the antenna assembly.

**\*A close-up view of the M<sub>axi</sub> variable capacitor blades. Also shown are the teflon guides which maintain the right distance between the blades of the opposite capacitor packs.**

**fig. 46**





fig. 47

\* The pin for the *Maxi* is installed on self-centering ball bearings. Secure the ball bearings with the nuts on the outside of the box. Then using the rubber hammer (fig. 47), carefully insert the pin.

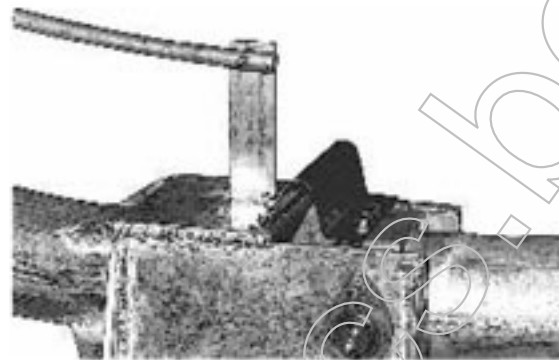


fig. 47/a

\* Close-up view of the flexible blade which ensures contact during the semi-loop's movement. The antioxidant paste should be used during assembly.



fig. 48

\* On side of the actuator is already attached to one side of the semi-loop. Position the piston side into the other semi-loop with the isolated arm, and lock it with the bolt (see fig. 48)

**Note:** see page 20 for the hardware list.

\* The *Maxi* is shown on a mobile platform during the assembly process. In this case tuning, efficiency and S.W.R. tests were conducted.

fig. 49

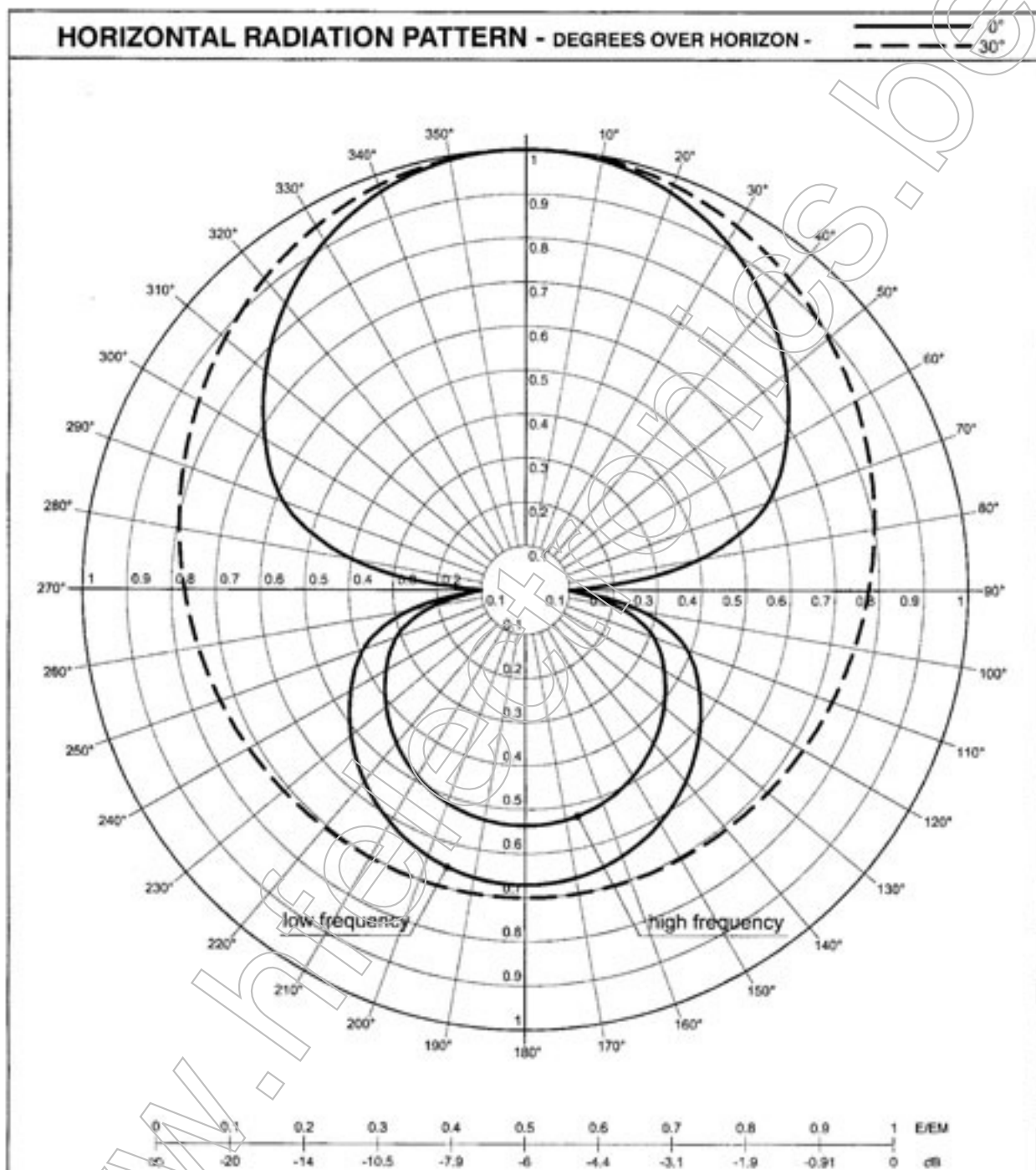


fig. 50

FREQUENCY RANGE 6.5 ÷ 29.8 MHz	
GAIN (dB) REFERRED TO THE HALF - WAVE DIPOLE :	
E.R.P. WITH 100 W. APPLIED TO THE ANTENNA CONNECTOR : (40 W. at 6.5 MHz) (90 W. at 29.8 MHz)	
MAGNETIC LOOP ANTENNA 13 VHF VERONA ITALY	MOD. BABY
	DATE 10-10-98
	CTRL

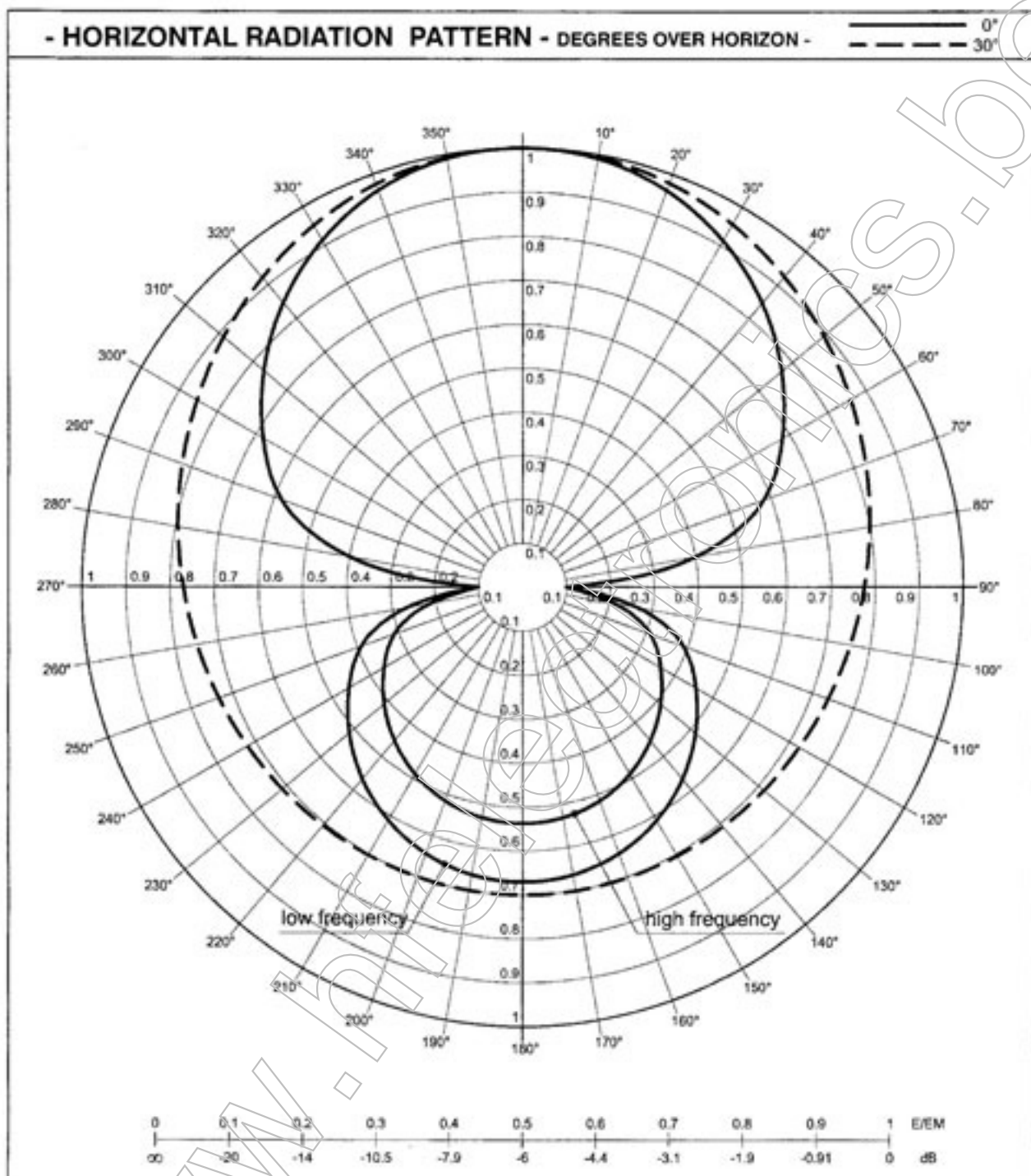


fig. 51

FREQUENCY RANGE 3.5 + 14.5 MHz

GAIN (dB) REFERRED TO THE HALF - WAVE DIPOLE :

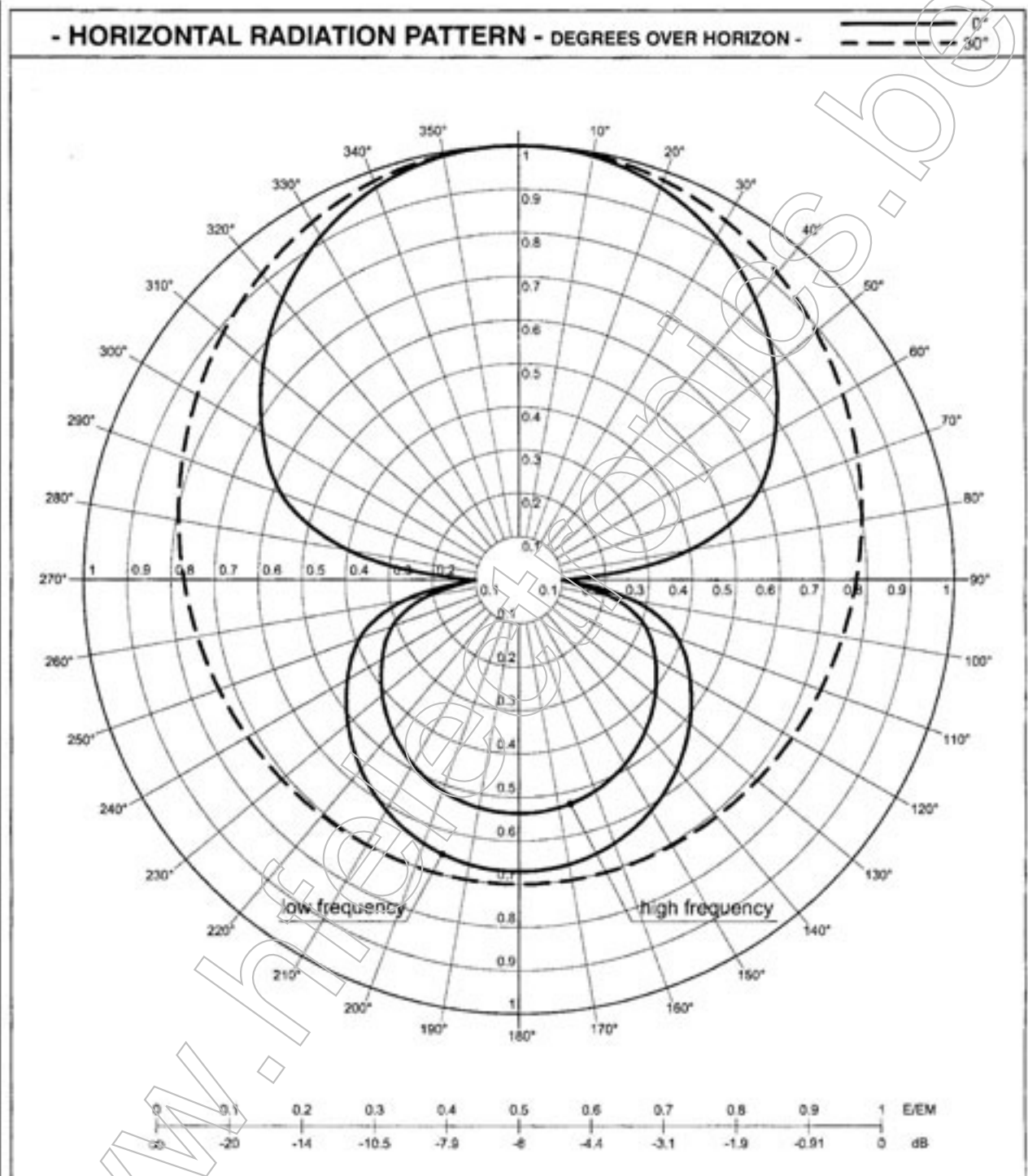
E.R.P. WITH 100 W. APPLIED TO THE ANTENNA CONNECTOR : (40 W. at 3.5 MHz) (90 W. at 14.5 MHz)

MAGNETIC LOOP ANTENNA 13 VHF VERONA ITALY

MOD. MIDI

DATE 10-10-98

CTRL



**fig. 52**

FREQUENCY RANGE 1.75 + 7.3 MHz	
GAIN (dB) REFERRED TO THE HALF - WAVE DIPOLE :	
E.R.P. WITH 100 W. APPLIED TO THE ANTENNA CONNECTOR : (40 W. at 1.75 MHz) (90 W. at 7.3 MHz)	
MAGNETIC LOOP ANTENNA 13 VHF VERONA ITALY	MOD. MAXI
	DATE 10-10-98
	CTRL



**SECTION IV**

[www.hfelectronics.be](http://www.hfelectronics.be)



Be sure that the maximum attention was used in the installation of the **LOOP ANTENNA**. It is recommended that you familiarize yourself with the commands of the LOOP ANTENNA. Prepare to move the **LOOP ANTENNA** to the final site by leaving the variable capacitor in the fully closed position.

At this point, connect the antenna to the transmitter using a 50Ω coaxial cable equipped with connectors. The cables connecting the antenna to the transmitter should be routed appropriately and anchored to prevent damage to them.

The **LOOP ANTENNA** can be installed using a rotator, which will make full use of the front-side characteristics (-25db see diagrams on pages 36-38 and the three dimensional representation on fig. 62).

It is highly recommended to use a **cross-needle S.W.R and Power meter**. Connecting this meter between the antenna and the transmitter will help determine the direct and reflected power at a single glance.

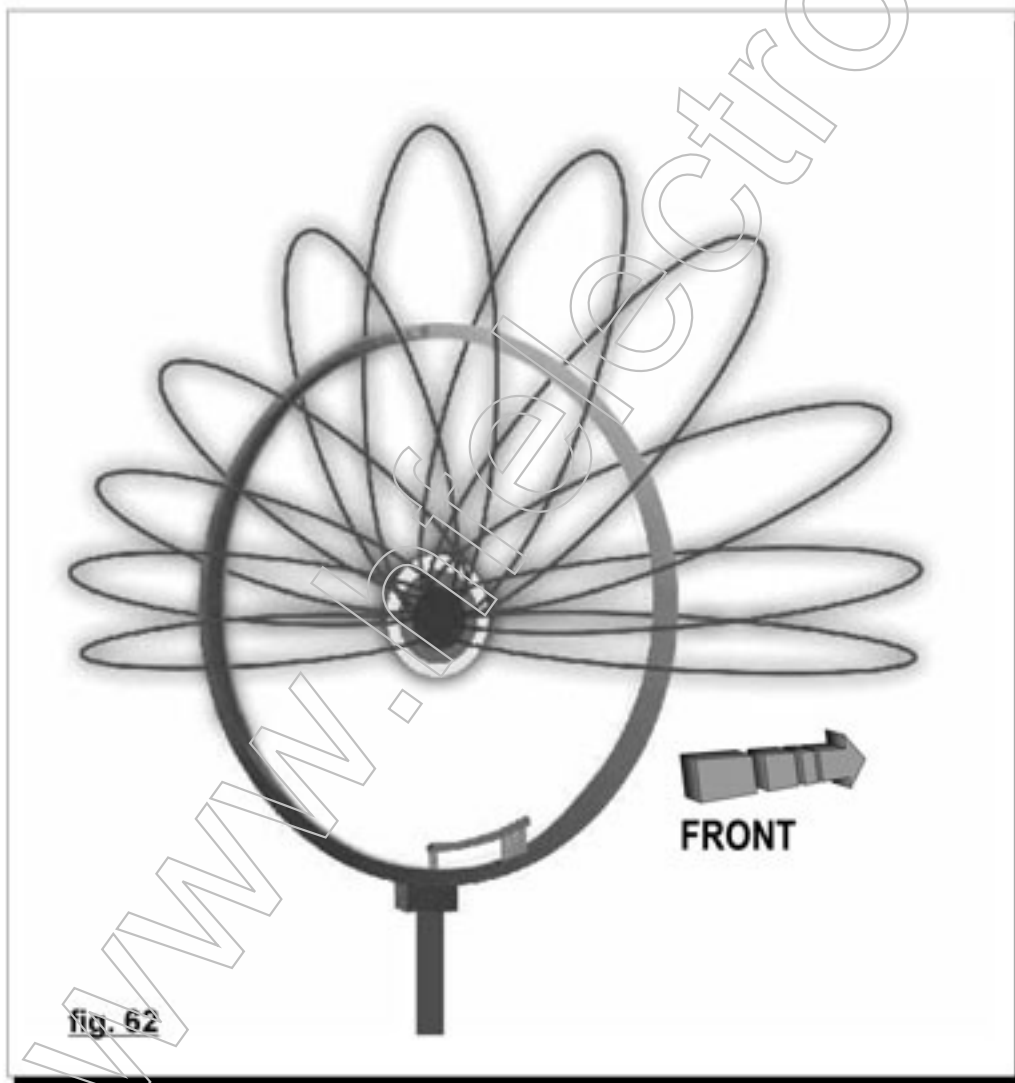


fig. 62

*The diagram to the left shows the radiation lobe for the various elevation angles, the pronounced ratios front to side, and the light ratio front to back . By installing the LOOP ANTENNA on a rotor the antenna's efficiency is maximized.*



## LOOP ANTENNA tuning, brief testing and the first connection

- A) Do not use the tuner. The modern equipment comes with a circuit which automatically switches on the internal tuner when the S.W.R. exceeds the manufacturer's **set value** (however, you must manually switch it off). Remember there is a three-digit number on the display. This number generally corresponds to the tuning capacitor's position. Through experimentation, the operator should verify the correlation between a particular frequency and the displayed number.
- B) Click (and keep down) the [**Close**] mouse button until the display gives the following message: **LIMIT!** <  
If the button is released at this point, the Controller counter will return to zero. This operation in effect **resets** the Loop Controller circuit. However, this reset can be performed only when the **variable capacitor blades are fully closed**.
- C) Select a band and a non occupied frequency which is within the frequency limits of the **LOOP ANTENNA** model used.  
Click on the [**Open**] or [**Close**] mouse button and tune the antenna for the maximum received noise. At this point go to the fine-tuning. Set the transmitter to either AM/FM mode (MIC GAIN to zero) or to CW mode. Set the transmitter to MINIMUM output power. Push and keep down the center button [slow, using pulse] and one of the side mouse buttons. Continue until the S.W.R. reaches the MINIMUM value. It may be necessary to switch between the two side mouse buttons in order to obtain the precise **MINIMUM** value since the fast tuning process may have overshoot the desired position.
- ❖ Follow the above procedure when operating in **LSB** mode and in the **1.75MHz** (**Maxi**), **3.5 MHz** (**Midi**) and **7.0 MHz** (**Baby**) frequency bands. However, set the frequency **1KHz** lower than the frequency used to operate in phone mode. This is necessary because the bandwidth of the antenna allows only the emission on the modulated signal. Because of the **L.S.B.** mode, this signal is **1KHz** lower than the one indicated by the transmitter.
  - ❖ For frequencies above **7MHz** (covered by the antenna), the **1KHz** lower shifting is not necessary because of the larger bandwidth.
  - ❖ Do not tune the **LOOP ANTENNA** in **SSB** mode using the classic "Ooola!". This method can cause a mistake in the tuning process.





**Suggestions to obtain the maximum  
from your LOOP ANTENNA**

The **LOOP ANTENNA** that we have described is certainly the most innovative product to transmit radio signals. However, we have provided some useful suggestions in case you can not obtain the maximum efficiency.

- a) If the S.W.R value does not reach the 1,3:1 ratio, potential causes may be:
1. The antenna is installed on uneven ground. For example on a sloped roof or at the top of the roof. In this case, rotate the antenna 90 degrees to obtain the correct S.W.R.;
  2. The antenna is mounted too close to metallic structures. In this case, we ask you to read again (on page 22) "where to install (preferably) the **LOOP ANTENNA**" and leave about 2m (6.56 ft) of space around the antenna.
- b) Again, familiarize yourself with the loop antenna tuning process, maybe repeating the process on a different frequency. Correct tuning is critical for obtaining the maximum efficiency for both receiving and transmitting. It is possible, especially in the lower frequencies, to exceed the minimum S.W.R. even when using the pulse command. In this case it will be sufficient to use the opposite pulse command button to obtain the minimum S.W.R. In some cases, the numbers on the display will go back one unit. This is not a problem since it represents a small tolerance that can be corrected by the reset command (see page 24 – RESET).
- c) Now you can go "ON AIR" with confidence. Select the frequency and the mode, and tune your **LOOP ANTENNA** for the minimum S.W.R.. You are using the best existing loop magnetic, and you will be satisfied for a long time.

We wish you the best connections and thank you again for selecting the **LOOP ANTENNA**.



### Laboratory Tests

Thorough laboratory tests were performed on the **LOOP ANTENNA** to verify the selectivity, the noise and the S. W. R..

Shown below are the results of the testing done on the **M<sub>1.01</sub>**, which was the first model developed by **Ciro Mazzoni** in the **LOOP ANTENNA** family.

fig. 63

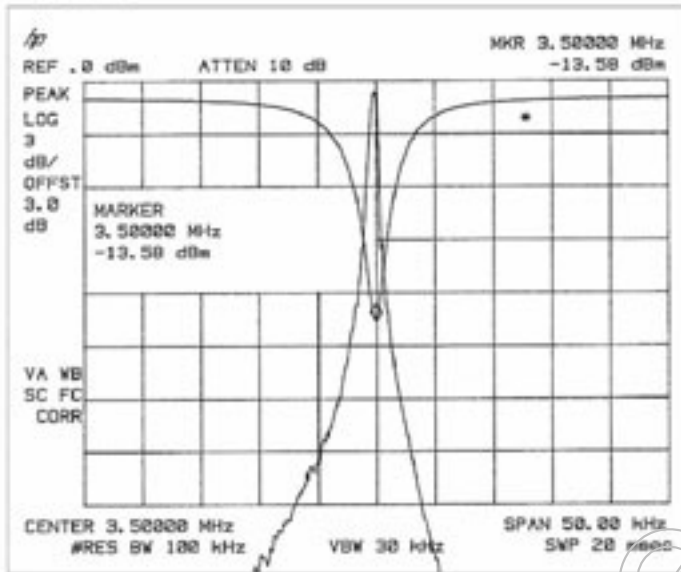
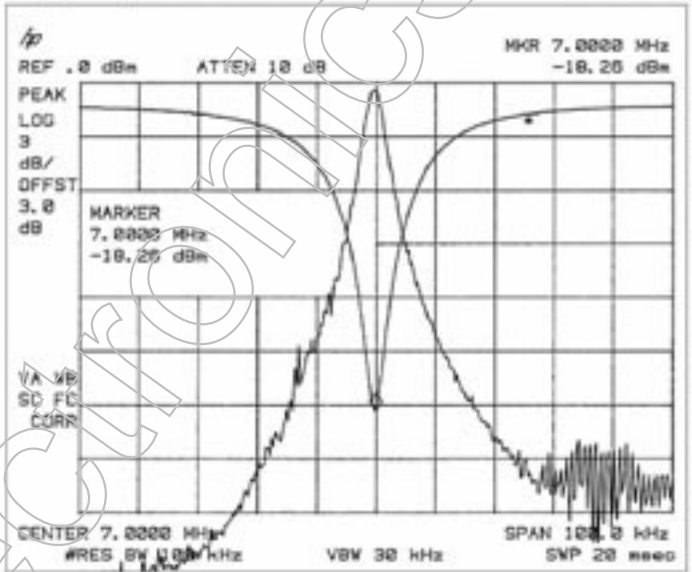


fig. 64



### SELECTIVITY AND S. W. R. TEST

fig. 65

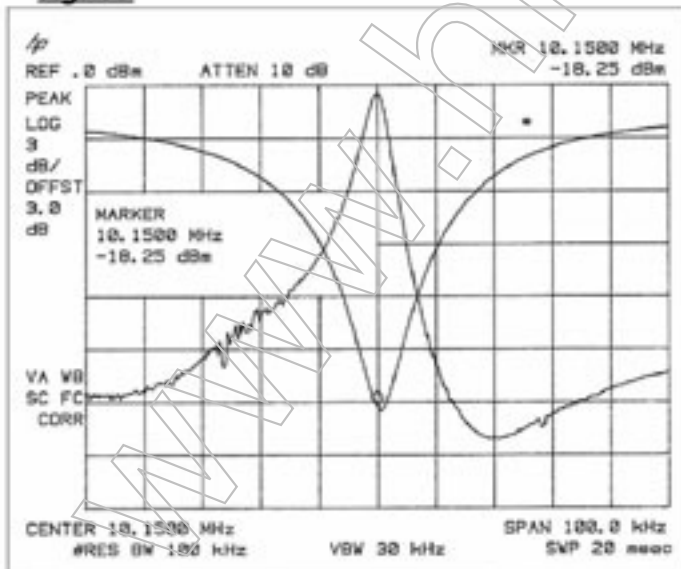
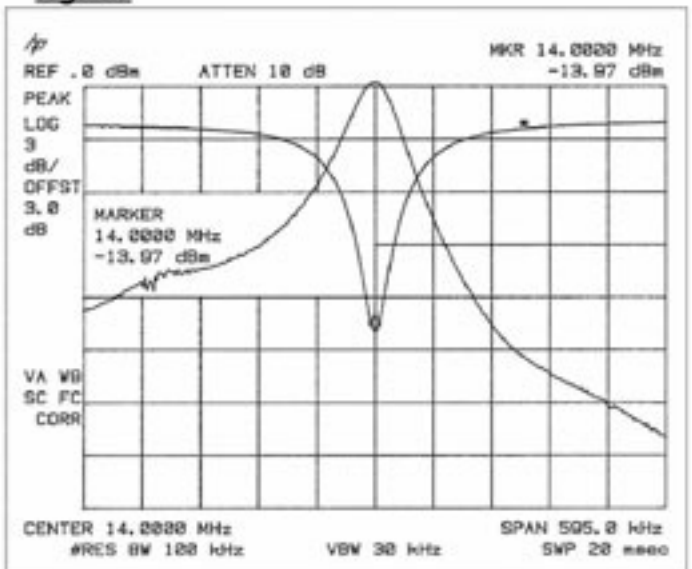
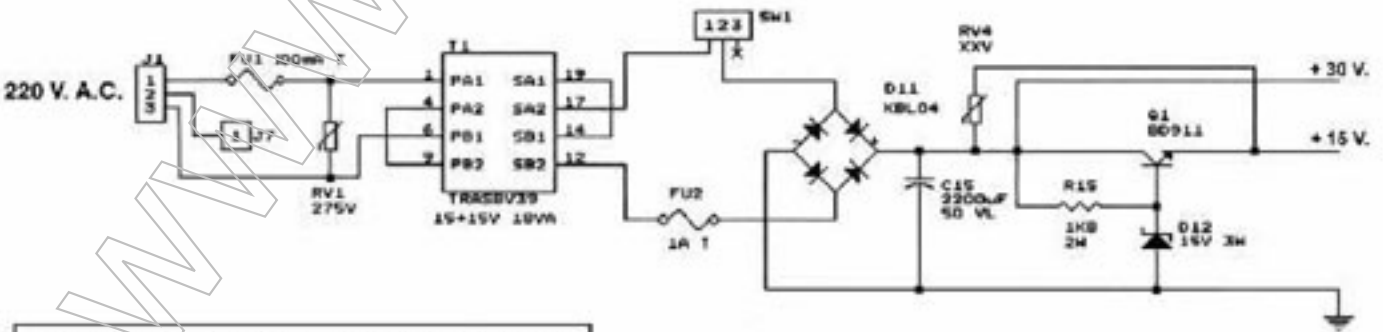
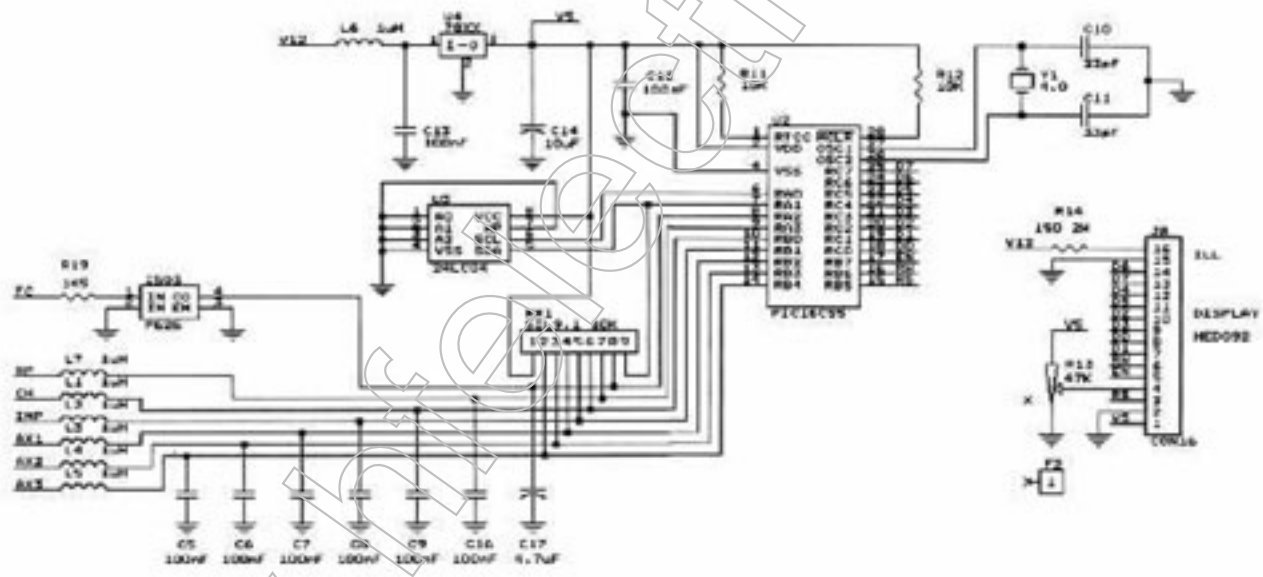
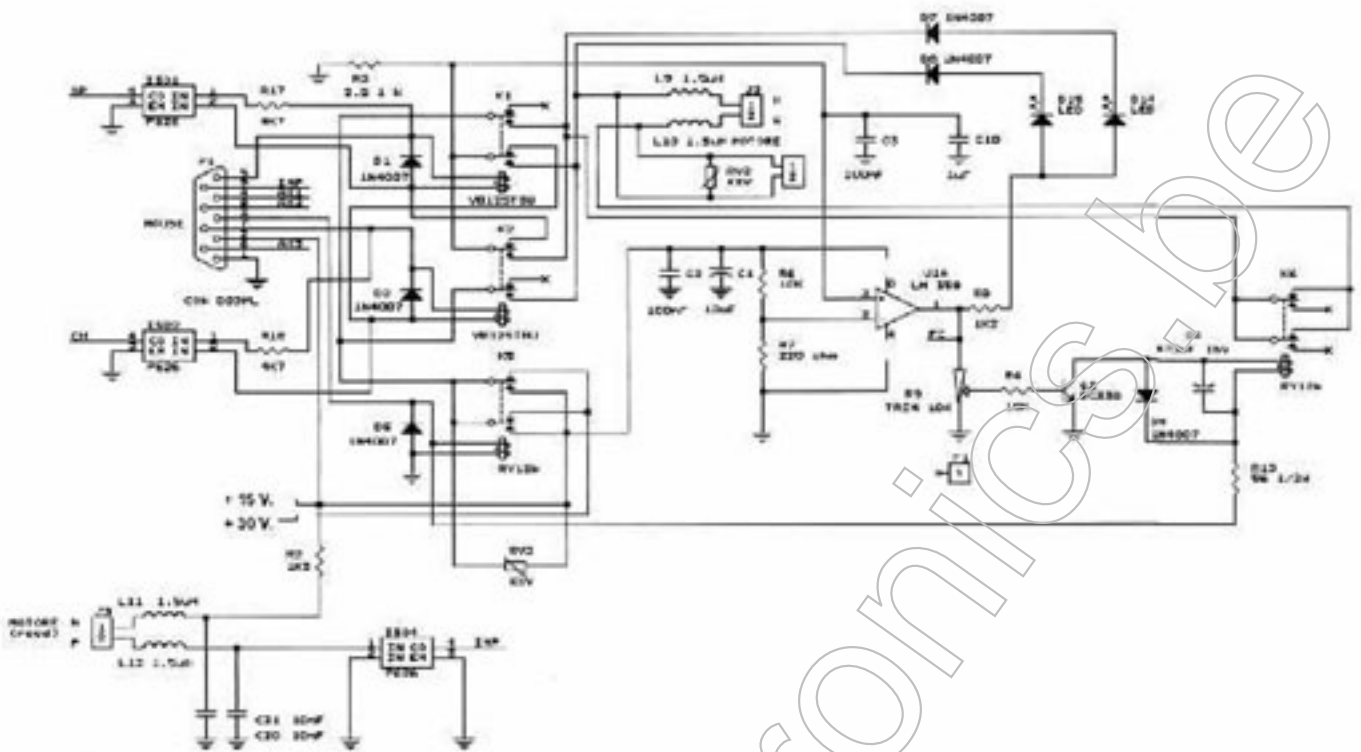


fig. 66





**LOOP CONTROLLER DIAGRAMS**  
MAY 1999 REV.03



## **LOOP ANTENNA Patents - Conditions - Warranty - Sales and Shipping - Special Antennas**

The **LOOP ANTENNAS** are patented (VR 95A - 000093/95). Additional patents are pending.

The **CIRO MAZZONI RADIOCOMUNICAZIONI**, constantly working to improve his products, reserves the right of variation and modification to the **LOOP ANTENNA** at any time and without notice.

The warranty of 1 (one) year starts on the date of delivery. The warranty covers the Antenna, the Loop Controller and the modified Mouse.

**CIRO MAZZONI RADIOCOMUNICAZIONI** holds exclusive and discretionary rights to revoke any warrantee if any parts are changed, damaged, or used in any way that is different from the assemble or use instructions. The warrantee is not valid for damage caused by natural events.

**CIRO MAZZONI RADIOCOMUNICAZIONI** does not assume any responsibility for direct or indirect damage caused to persons or property derived from the installation and/or use of the **LOOP ANTENNA**.

Purchase of one or more **LOOP ANTENNAS** must be submitted in writing and accompanied by the full amount of the purchase (by money order, certified check, or credit card). The full amount consists of the price of the antenna plus taxes and shipping and handling.

The prices are reported in the Price List valid at the time of purchase.

The merchandise is shipped through carriers at the purchaser's risk. Any problems should be resolved with the carrier. All other conflicts are resolved through the Court of Verona, Italy.

The **CIRO MAZZONI RADIOCOMUNICAZIONI -Upon Request-** produces **special LOOP ANTENNAS** for military, commercial and naval use (even for fixed frequency) and for power greater than the one specified on the manual. Prices are to be determined.